

PisaSmooth
modern

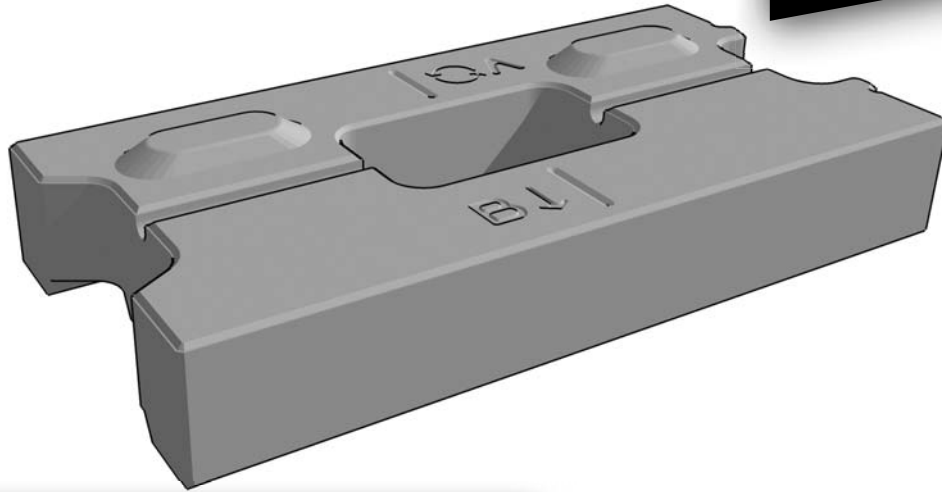

Contemporary Styling

Installation Guide

gravity walls | retaining walls | residential & commercial | steps | planters | pillars



RisiStone[®]
retaining wall systems

PisaSmooth

modern

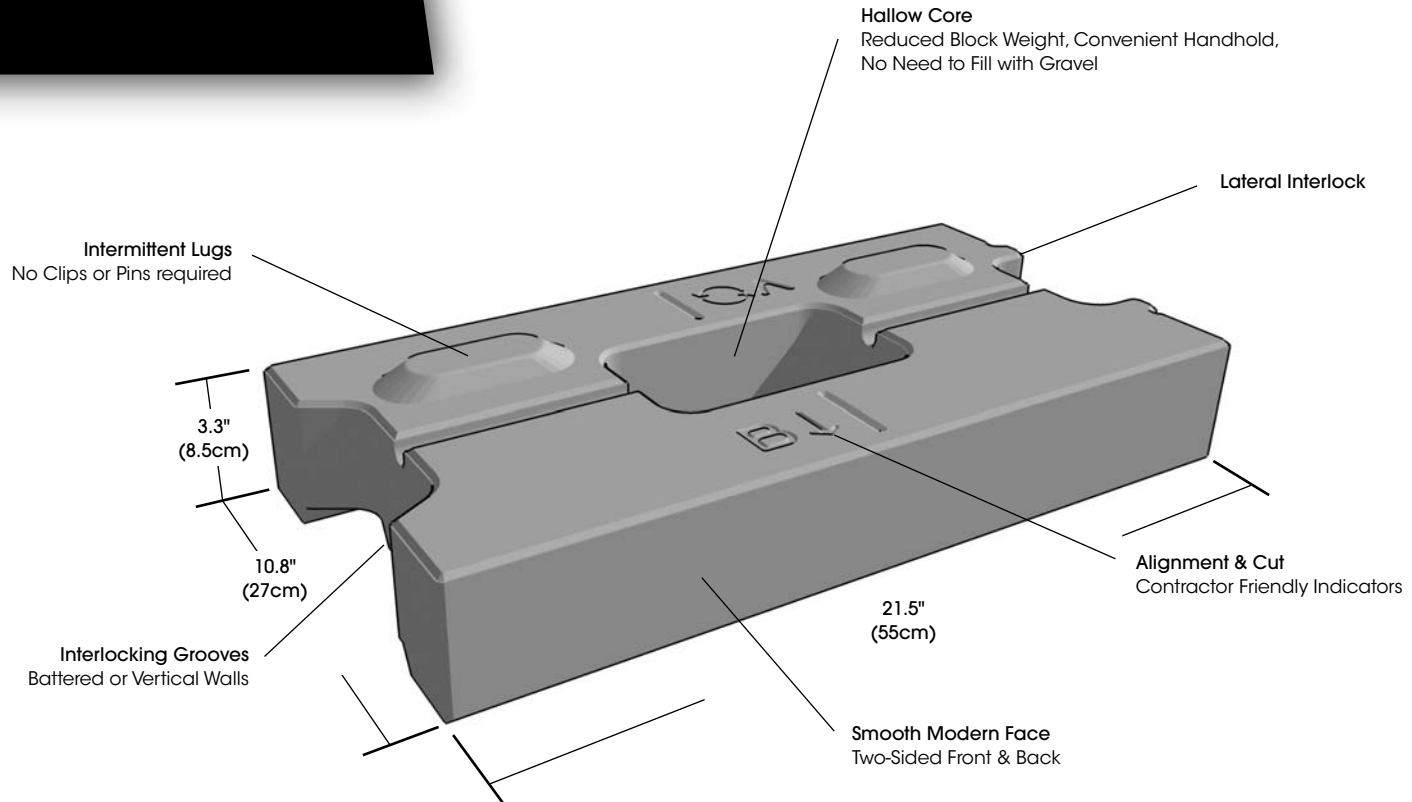

This guide, provided at no cost by Risi Stone Inc. is intended to serve only as an informational resource for PisaSmooth™ product purchasers. It is provided for reference only and is not a substitute for, and does not replace the need for registered professional engineering Design and experienced contractor installation. Risi Stone Inc. strongly urges purchasers to exercise diligence and care in the selection, design, installation and use of any construction materials.

RISI STONE INC. DISCLAIMS ANY AND ALL LIABILITY FOR DAMAGES OR LOSSES OF ANY KIND OR NATURE TO PERSON(S) OR PROPERTY, INCLUDING, BUT NOT LIMITED TO, DIRECT, INDIRECT, INCIDENTAL, CONSEQUENTIAL OR PUNITIVE DAMAGES, ATTORNEYS' FEES OR COSTS, ARISING OUT OF OR RELATED TO THE USE OF THE GUIDE, INCLUDING, BUT NOT LIMITED TO ANY WORK THAT MAY BE PERFORMED BY ANY CONTRACTORS OR INSTALLERS.

BY USING THE GUIDE, YOU AGREE TO WAIVE ANY AND ALL CLAIMS AGAINST RISI STONE INC., ITS OFFICERS, DIRECTORS, EMPLOYEES, VOLUNTEERS, REPRESENTATIVES, CHAPTERS AND AFFILIATES, AND HOLD THEM HARMLESS FOR ANY DAMAGES OR LOSSES OF ANY KIND TO PERSON OR PROPERTY, INCLUDING, BUT NOT LIMITED TO, DIRECT, INDIRECT, INCIDENTAL, CONSEQUENTIAL OR PUNITIVE DAMAGES ARISING OUT OF OR RELATED TO THE USE OF THE GUIDE, INCLUDING BUT NOT LIMITED TO THE SELECTION, DESIGN, INSTALLATION OR USE OF ANY MATERIALS, STRUCTURES, COMPONENTS OR ASSEMBLIES.

RISI STONE® and PisaSmooth™ are trademarks of Risi Stone Inc.

© 2020 Risi Stone Inc. All Rights Reserved.

Version 1.0 | August 1, 2020

Introduction

Overview of a Successful Project	4
Understanding the Design	5
Components of the Design	6
PisaSmooth Modern Wall	7
Features & Advantages	7

Installation Details

Corners	8
Stairs	12

Wall Construction

Gravity Wall Installation.	16
Geogrid Reinforced Wall Installation.	22

Additional Construction Details

Soil Conditions	29
Drainage	30
Posts, Guard Rails & Obstructions	32

Overview of a Successful Project

The following Installation Guide has been provided to mainly address those aspects of Wall construction that are unique and/or proprietary to the PisaSmooth Retaining Wall System. For all general Segmental Retaining Wall construction guidelines, Risi Stone Systems recommends the Contractor refer to the NCMA (*National Concrete Masonry Association*) Segmental Retaining Walls Best Practice Guide for the Specification, Design, Construction, and Inspection of SRW Systems. This excellent resource provides the comprehensive level of detail required for successful SRW Projects. Refer to www.ncma.org.

The following procedure is recommended for the construction of segmental retaining walls over 36"(1m) in height, or as required by local building codes.

Clear Plan

- Aboveground Site Assessment: existing grades, structures, utilities, property lines, visible water features, etc., established.
- Contact all utility companies to confirm location of underground utilities that may not be visible in aboveground assessment.
- Proposed site modifications defined by Designer (*landscape architect, engineer, architect*) based on owner's requirements and site limitations. Includes proposed grades, retaining wall geometry, slopes, proposed use of land (*parking areas, water detention, landscape*), relocation of existing structures/utilities, new structures/utilities, location of trees, etc.
- Project drawings generated and submitted to appropriate agencies for approval.
- Investigate local building codes and apply for all permits required.

Assessment of Subsurface Conditions

- Geotechnical Investigation conducted to evaluate subsurface conditions of site, including soil types, characteristic properties, in-situ state, groundwater conditions, overall slope stability and bearing capacity.
- Recommended Design parameters, construction/excavation techniques, effects of proposed and existing structures, ground improvements, erosion protection, drainage considerations, anticipated settlement, etc., should be identified.

Site-Specific Retaining Wall Design

- Grading Plan & Geotechnical Investigation provided to the Wall Design Engineer.
- Wall Design Engineer must be a Professional Engineer licensed in the applicable Province or State. The Design must synthesize all available information and include cross section and/or elevation view drawings, specifications, calculations, quantities, and related construction details.
- The Design should be checked for Global Stability by the site Geotechnical Engineer.

Pre-Construction meeting

- For larger scale Projects, we recommend that all involved parties (*Designers, Owner's representative, General Contractor, Contractor, Inspecting Engineer, Supplier, etc.*) attend a pre-construction meeting to define schedule and clearly state responsibilities.
- Parties not directly involved with the Design and construction of the wall, but who may do future work that could influence the wall (*e.g. paving, installing fences*) should attend the meeting to understand the limitations of the wall and address precautions.

Experience has shown that this simple step prevents a multitude of potential problems!

Qualified Professional Engineer Hired for Inspection/General Review

Inspection and General Review of the proposed SRW must be conducted by a qualified third-party engineer (*called the General Review Engineer*).

As much of the General Review is Geotechnical in nature (compaction testing, soil and groundwater assessment) it often makes the most sense to have the Site Geotechnical Engineer conduct the General Review.

Proper General Review of Construction should include all aspects of the installation. The scope of the GRE's responsibilities include, but are not limited to:

- Inspection of all materials used in construction (*SRW units, backfill, drainage material, reinforcement, other structures*).

Understanding the Design

- Verification that the Design is compatible with the site in all respects.
- Identification of discrepancies between the plan and/or SRW Design and actual site conditions, and subsequent notification of Wall Designer.
- Continuous evaluation of site conditions, surface water and groundwater, compaction testing, foundation bearing capacity, excavation procedures, construction practices for safety and compliance with Design.
- Ensuring wall is constructed according to Design (*geogrid lengths and type, Wall heights, etc*).
- Finally, the GRE will provide a letter to the owner stating that “the Wall was constructed in General Conformance with the Plans and Specifications”.

Proper Installation

- Adherence to Design, specifications, details, guides, and good construction practice is necessary.
- Conducted under supervision of the GRE.

Final Grading

- Final grading should be conducted as soon as possible following construction to divert water away from the wall and create the optimum condition for great performance.

Safety Notes

- Ensure all workers are well-versed in the proper use of all equipment and vehicles.
- Prior to each use, inspect all machinery to ensure that it is in good condition.
- Do not exceed the recommended load/speed/capacity specified by the equipment manufacturer.
- Ensure overall maintenance of all machinery is kept up.
- Follow all occupational health & safety guidelines set forth by your local government.

Depending on the stage in the design process, there are generally three potential types of Design:

Typical Design – Not for Construction

A Typical Design is a Non-Site-Specific Wall Cross Section or Design Table. Selected based on preliminary information regarding proposed maximum wall height, use of structure, grading, etc. Suitable for preliminary cost estimates, feasibility studies, and conceptual approvals. Not for Construction.

Preliminary Design – Not for Construction

A site-specific Design produced for preliminary purposes when some component of the required design information is not yet available. Includes all elements needed to construct the wall, but is not considered ready for construction as it remains contingent on verification of some site-specific detail(s). Includes site-specific cross section drawings, elevation views, specifications, quantity calculations, details, statement of limitations, etc. Not sealed by the Designer.

Final Design

All necessary information has been established and the Design has been deemed ready for construction. This type of design is sealed by the Designer.

Components of the Design

The Design should clearly provide all information necessary to construct the proposed SRW structure. The basic components are as follows:

Design Notes / Limitations

The Design should include information regarding the design standard used, limitations of design, status of design (*preliminary or final*), design assumptions, purpose of the wall, and potential construction issues.

Cross Section Drawing(s)

The cross section drawing is usually provided to illustrate the general arrangement of the wall, soil zones, assumed parameters, structural elements, water levels, etc. A cross section drawing is normally provided for the maximum height section through the wall and/or the most critical section. Additional cross sections may be provided to indicate variable conditions or wall orientation (*terraces/location of structures*) throughout.

Elevation View Drawing(s)

The elevation view or “face” view of the wall depicts the wall as a whole, essentially laying the wall out flat on the page. This drawing details the overall geometry of the proposed wall, steps at the top and bottom of wall, required geogrid length and placement (*where applicable*), location of other structures, etc.

Calculations and Quantity Estimates

Most design reports contain a summary of quantities of Block, Geogrid, Infill, etc. The contractor is responsible for verifying the quantities provided by checking the most recent grading information, and/or site grading, against the elevation view provided.

Details

The cross section and elevation view drawings are to be used in conjunction with the related detail drawings. These may include handrails, corners, curves, stepping foundation, steps, etc. Adherence to these details is vital for optimum wall performance.

Specifications



The Design should include standard specifications that outline specific requirements of the Design, Construction, Materials, Certification, and Finishing.

PisaSmooth™ Modern Wall

The PisaSmooth system is a modular concrete retaining wall system that is used to stabilize and contain earth embankments, large and small.

The PisaSmooth Wall System is a fully engineered, Structural Retaining Wall System. Constructed as either a “Gravity” wall (*no geogrid*) or a Geogrid Reinforced Wall, PisaSmooth can be used for applications up to 20ft(6m) or even higher with proper Design.

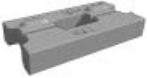
The Unique appearance of PisaSmooth also makes it ideal for smaller Landscape type applications, such as garden walls, raised patios, or planters.

PisaSmooth Blocks	Width	Height	Depth	Weight
Standard				
	21.5" 55cm	3.3" 8.5cm	10.8" 27cm	54lbs 24kg
Corner Install Flipped				
	21.5" 55cm	3.3" 8.5cm	10.8" 27cm	65lbs 29kg
Coping / Closed-End				
	21.5" 55cm	3.3" 8.5cm	13.7" 35cm	82lbs 31kg

Versatile Design

Create Battered or Vertical Walls by rotating the blocks, alternating the Batter Indicator arrow **Forward** or **Backward** every other course.

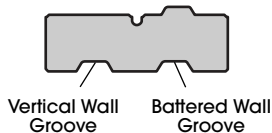

Battered

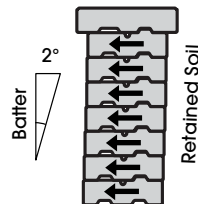

Vertical

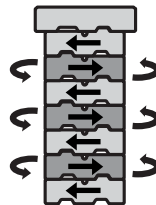

Features & Advantages

The PisaSmooth system has a number of features that make it unique. They have been developed to enable a faster and more accurate installation by the contractor and to provide a stronger, more beautiful and more economical structure for the owner.

Feature	Benefit
Lateral Interlock	<ul style="list-style-type: none"> The unique lateral interlock provides superior strength wall & auto-alignment Easy to remove Lateral Lock lugs
Near-vertical batter	<ul style="list-style-type: none"> Expands usable site – only 1/8"(1cm) setback per course, 2° batter Makes a smooth and precisely-aligned wall face
Integral Lug & Groove Design	<ul style="list-style-type: none"> No separate pins or clips to install Easy to remove lugs
No Fill Core	<ul style="list-style-type: none"> Ensures maximum weight of each block is present Reduced installation time & labour costs
Battered OR Vertical Walls	<ul style="list-style-type: none"> Use the batter orientation arrow direction indicator to create battered walls. OR vertical walls by rotating the blocks, alternating the Batter Indicator arrow Forward or Backward every other course.

Coping / Step Tread

The Step Groove automatically provides the correct amount of nosing regardless of lug orientation.

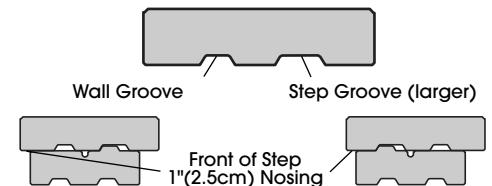

Outside 90° Corners Battered Walls

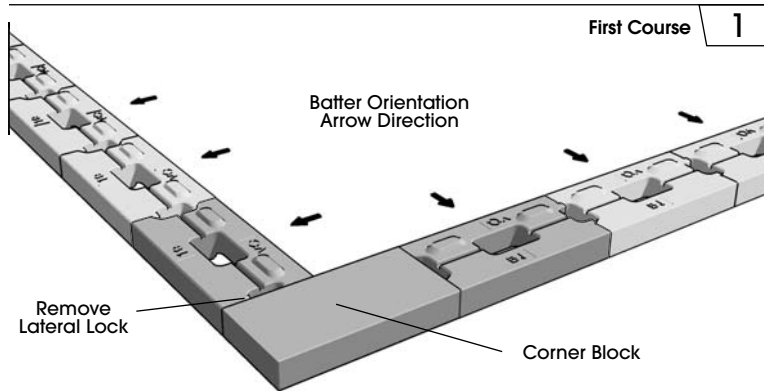

At the corner location, place a corner block as shown. Abut a standard block next perpendicular to the corner block, ensuring the Batter Indicator is pointing **Forward**. Remove the Lateral Lock ensuring the standard block is flush with the corner block. Continue to install standard blocks as shown with the Batter Indicators pointing **Forward**.

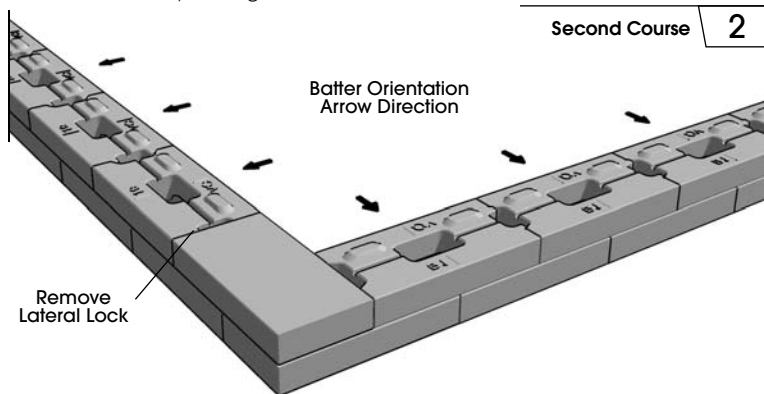

Continue the next course by placing a corner block in the opposite direction, engaging the block below using the Batter Groove. Remove the Lateral Lock ensuring the standard block is flush with the corner block. Continue to install standard blocks as shown with the Batter Indicators pointing **Forward**.

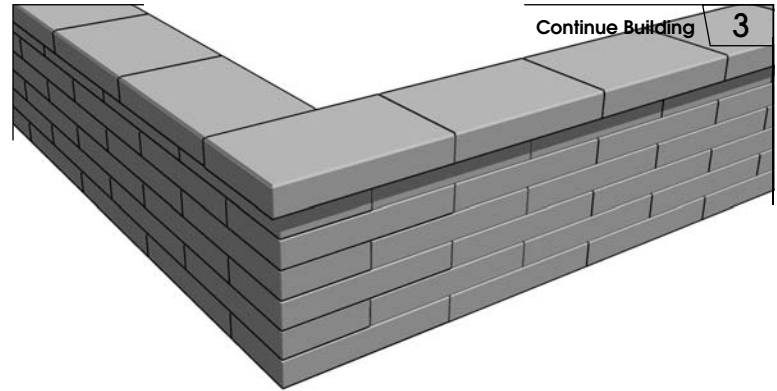

Repeat until desired wall height is achieved. Finish the corner off with a closed-end coping block.

Install coping using the Wall Groove for consistent overhang (page 7).

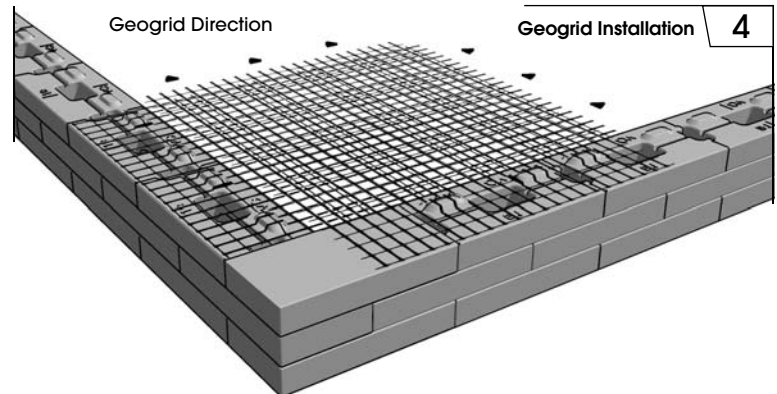

Overlap geogrid as shown where the Design requires.

Geogrid Reinforcement must be placed with the “Strong Direction” (Machine Direction) perpendicular to the face, and within 1”(25mm) of the Block face.

Outside 90° Corners Vertical Walls

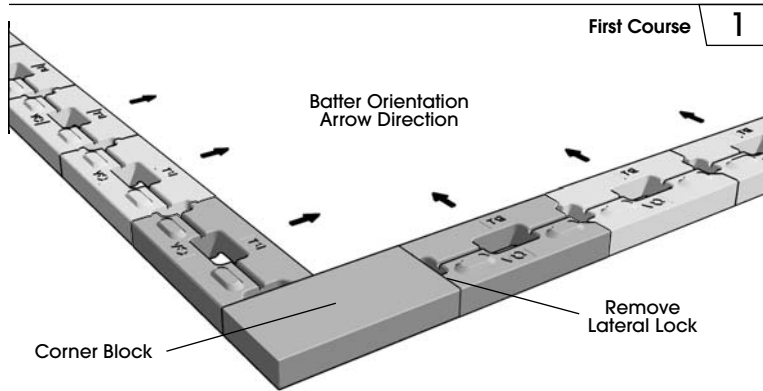

Install blocks on the base course with the Batter Indicator pointing **Backward**. At the corner location, place the corner block as shown. Abut the next block perpendicular to the first, removing the Lateral Lock ensuring the block are flush. **Refer to Features & Advantages (page 7) for more information on Vertical Walls.**

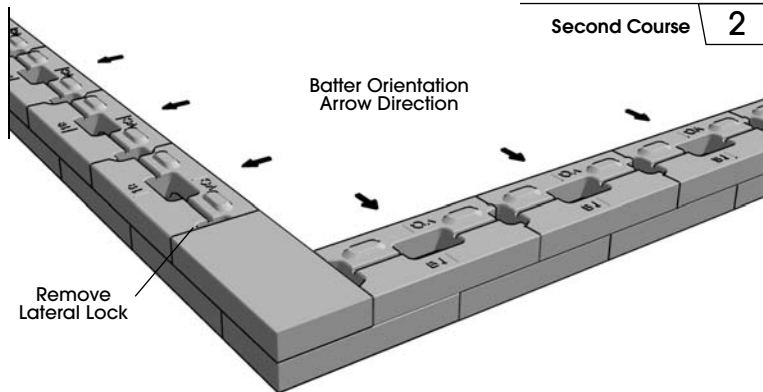

Vertical walls are constructed by rotating the blocks, alternating the Batter Indicator arrow **Forward** or **Backward** every other course. Continue by placing the next Corner in the opposite direction, with the Vertical Groove engaged, ensuring blocks are Flush. Repeat until desired wall height is achieved. Finish the corner off with a closed-end coping block.

Outside 90° Corners Combination

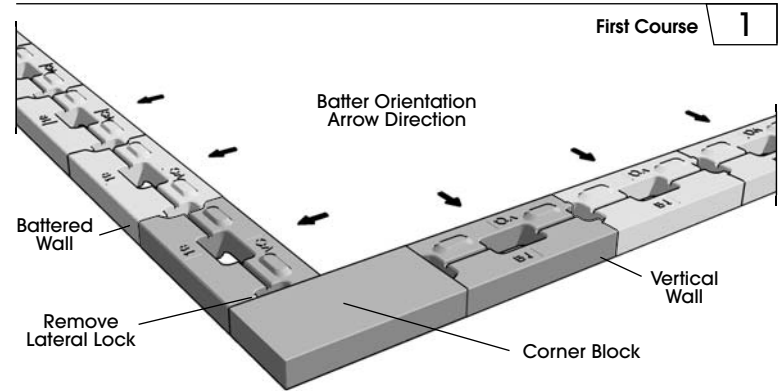

Combination corners have a Battered wall on one side and Vertical wall on the other, this is ideal for step side walls to eliminate difficult cuts.

Install blocks with the Batter Indicator pointing **Forward**. Remove the Lateral Lock ensuring the standard block is flush with corner block.

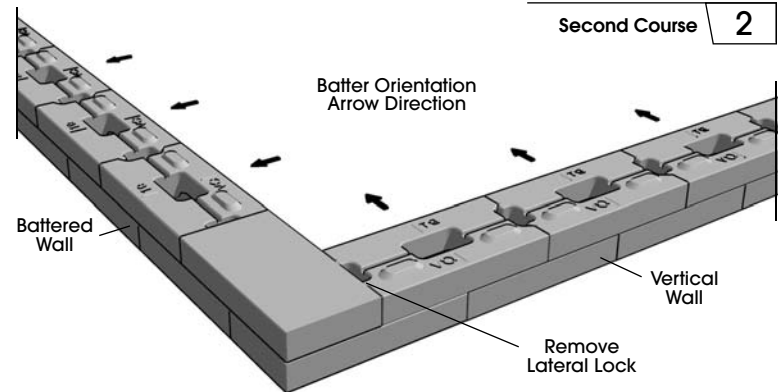

Commence second course by placing a corner block in the alternate direction with the Battered Groove engaged. For the **Battered wall**, place standard blocks to complete the course, ensuring the Batter Indicator points **Forward**. For the **Vertical wall**, ensure the Batter Indicator points **Backward**. Repeat until desired height is achieved and finish the corner with a closed-end coping block.

Inside 90° Corners Battered Walls

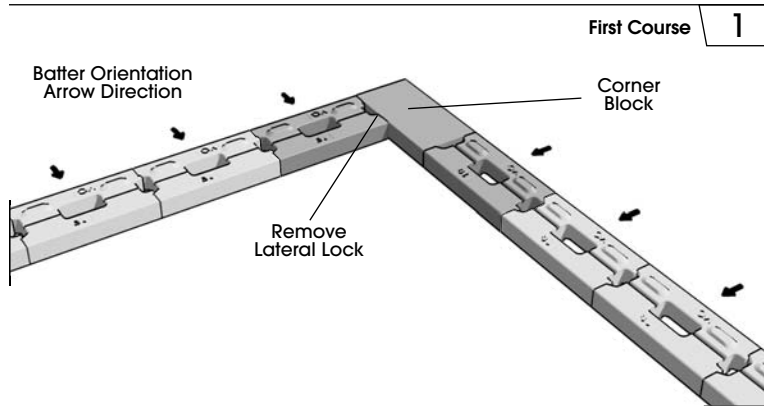

Install blocks on the base course with the Batter Indicator pointing **Forward**, leading to the corner. Remove the Lateral Lock ensuring the standard block is flush with the corner block.

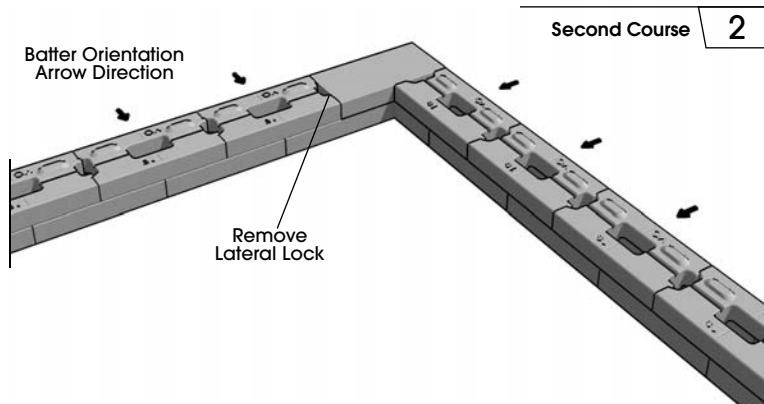

Commence second course by placing a corner block in the alternate direction, with the Batter Groove engaged. Place standard blocks to complete the course, ensuring the Batter Indicator points **Forward**.

Remove the Lateral Lock ensuring the standard block is flush with the corner block.

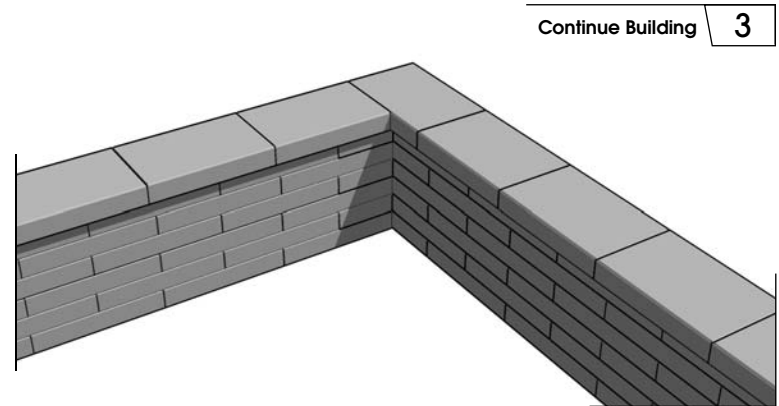

Repeat until desired wall height is achieved. Finish the corner off with a closed-end coping block.

Install coping using the Wall Groove for consistent overhang (page 7).

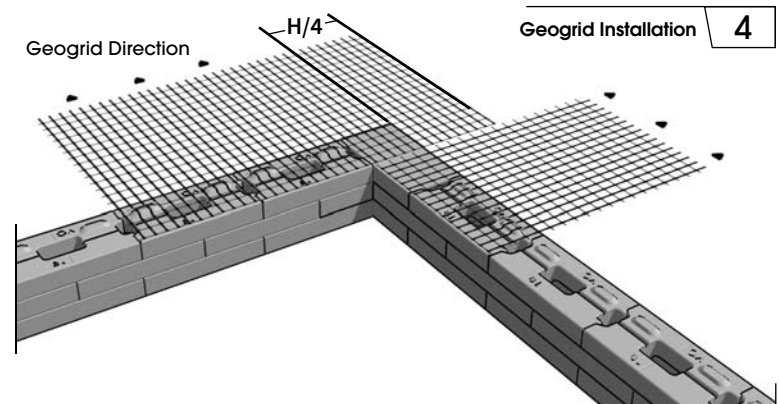

The geogrid should be placed within 1" (2.5cm) of the face of the block. As it is only necessary to have geogrid extending directly away from the wall, a gap will result in the geogrid layer as shown.

Alternate direction of geogrid reinforcement H/4 extension on subsequent geogrid layers.

Inside 90° Corners Vertical Walls

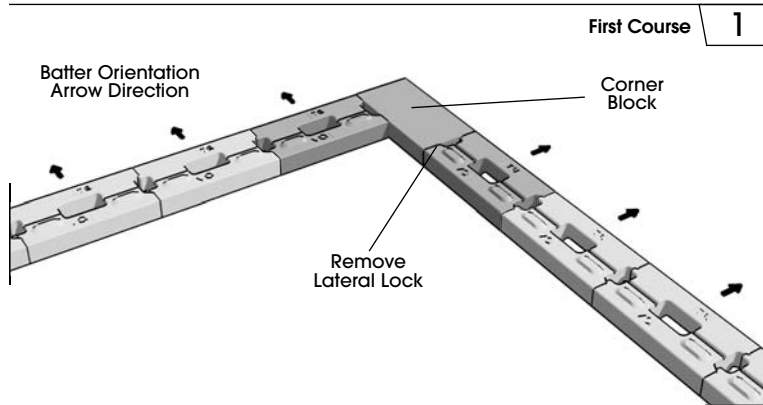

Install blocks on the base course with the Batter Indicator pointing **Backward**, leading to the corner. Remove the Lateral Lock ensuring the standard block is flush with the corner block.

Refer to Features & Advantages (page 7) for more information on Vertical Walls.

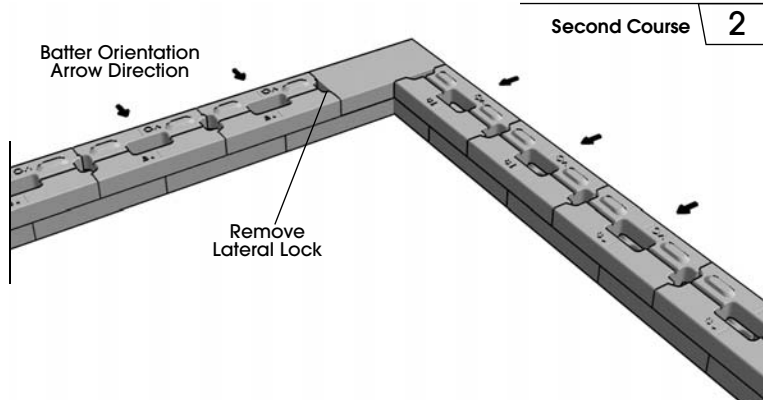

Commence second course by placing a corner block in the alternate direction, with the Vertical Groove engaged. Place standard blocks to complete the course, ensuring the Batter Indicator points **Forward**.

Remove the Lateral Lock ensuring the standard block is flush with the corner block.

Inside 90° Corners Combination

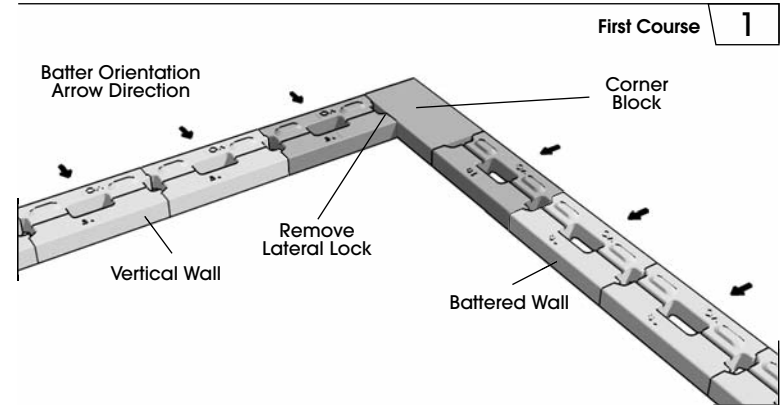

Combination corners have a Battered wall on one side and Vertical wall on the other. This is ideal for step side walls to eliminate difficult cuts.

Install blocks on the base course with the Batter Indicator pointing **Forward**, leading to the corner. Remove the Lateral Lock at the corner block.

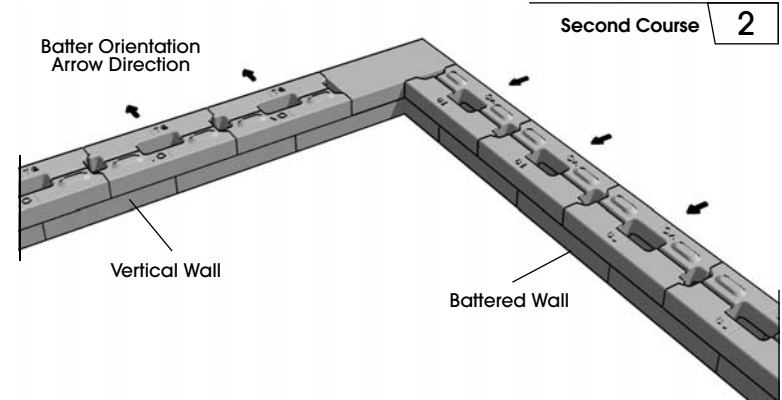

Commence second course by placing a corner block in the alternate direction with the Vertical Groove engaged. For the **Battered** wall, place standard blocks to complete the course, ensuring the Batter Indicator points **Forward**. For the **Vertical** wall, ensure the Batter Indicator points **Backward**. Repeat until desired height is achieved and finish the corner with a closed-end coping block.

Inset Stairs

The following steps provide guidelines for the construction of inset or inside stairs. Proper compaction within the walls and under the treads, along with the use of geogrid to prevent settlement, is critical to the long-term performance.

Ensure to consult your local Building Codes for limitations on Riser Height, Step Tread dimensions and handrail requirements. All stair components should be secured with approved concrete adhesive.

Number of Steps = Total Height / 6.7" (17cm)

Battered Walls Total Run = [No. of Steps - 1] x [Tread Depth - 1/8" (0.3cm)]

Vertical Walls Total Run = [No. of Steps - 1] x [Tread Depth]

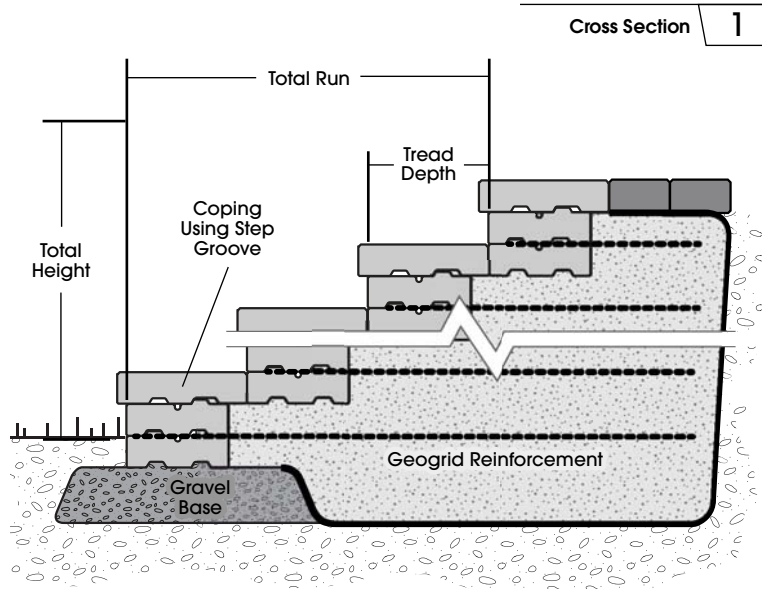

To prevent settlement, it is recommended to include geogrid reinforcement within each course of steps. All stair components should be secured with approved concrete adhesive.

First Step 2

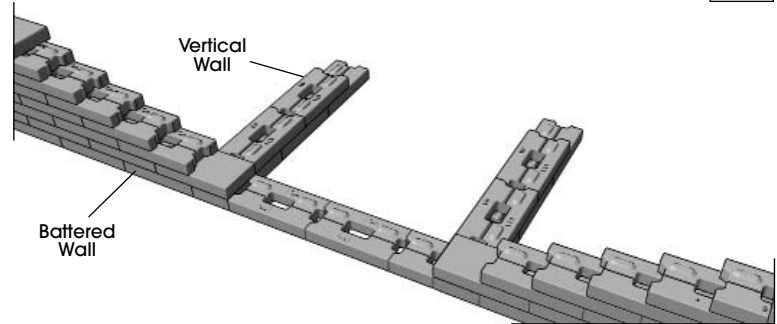

Start the wall with two outside 90° Combination Corners (page 9) distanced as specified in the Design. Place coping blocks between to form the first step riser, measure and cut if required.

Gravel Fill & Compaction 3

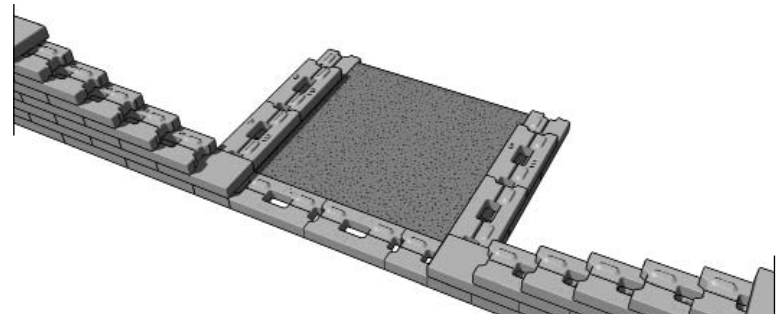

Fill the reinforced zone with imported, free draining gravel and compact to 95% SPD.

It is recommended to use a washed 1/4" angular chip gravel. This material requires less rigorous compaction and will help prevent outward movement of the blocks due to compaction pressures during construction. (ASTM#8)

Tread & Geogrid Layer **4**

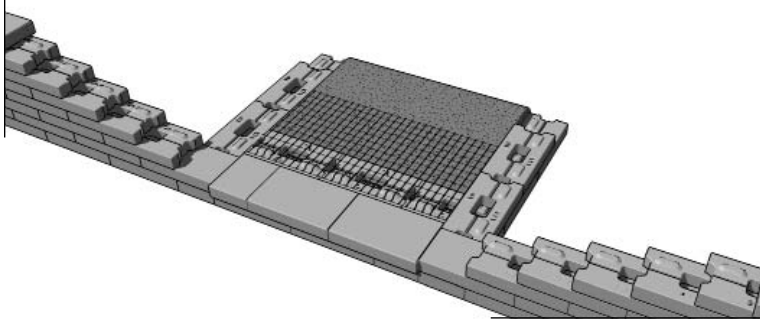

Place coping blocks as shown using the Step Groove (*page 7*). Use closed-end coping on the outside edges as these will be visible. Place a row of standard blocks directly behind the coping. Fill with gravel and compact.

Experience has shown that the inclusion of geogrid reinforcement within each course of steps reduces the effect of settlement.

Second Step & Geogrid **6**

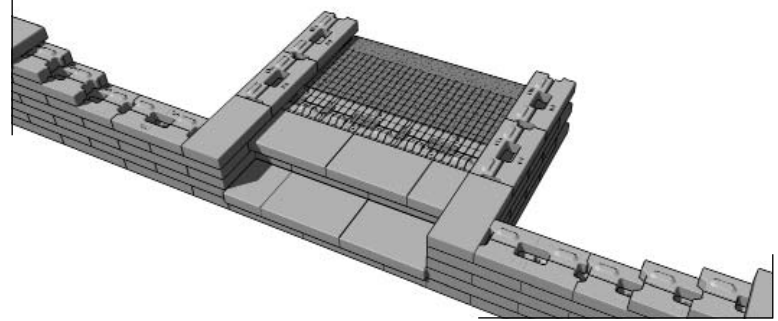

Fill with gravel and compact. Place another geogrid reinforcement layer.

Second Step **5**

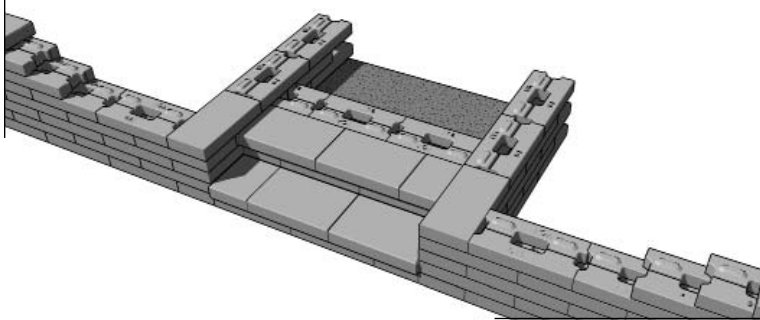

Place the next courses. For best results, offset the cuts to create a bond pattern with the step below. At each layer, fill the reinforced zone with imported, free draining gravel and compact to 95% SPD.

Second Step **7**

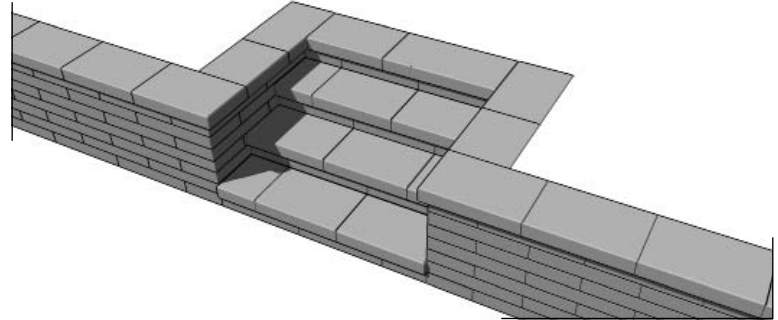

Repeat until desired wall height is achieved. Finish off with coping blocks.

Protruding Stairs

The following steps provide guidelines for the construction of protruding or outside stairs. Proper compaction within the walls and under the treads, along with the use of geogrid to prevent settlement, is critical to the long-term performance.

Ensure to consult your local Building Codes for limitations on Riser Height, Step Tread dimensions and handrail requirements. All stair components should be secured with approved concrete adhesive.

Number of Steps = Total Height / 6.7."(17cm)

Battered Walls Total Run = [No. of Steps - 1] x [Tread Depth - 1/8"(0.3cm)]

Vertical Walls Total Run = [No. of Steps - 1] x [Tread Depth]

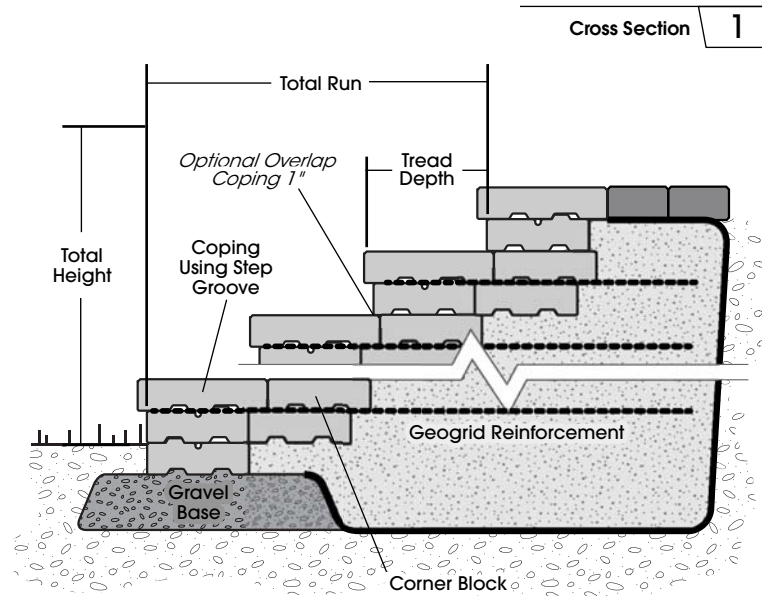

To prevent settlement, it is recommended to include geogrid reinforcement within each course of steps. All stair components should be secured with approved concrete adhesive.

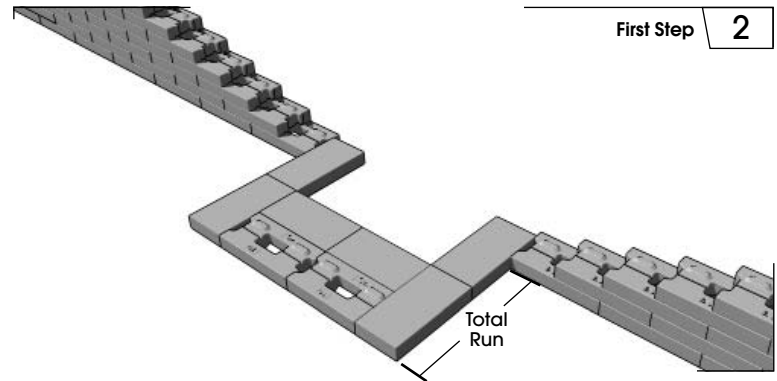

Start the wall with two inside 90° Combination corners (*page 11*) and two outside 90° corners. Use the Total Run formula to determine the distance out from the face of the wall where the front of the first riser should be placed. Place another row of corner or coping blocks directly behind the first set.

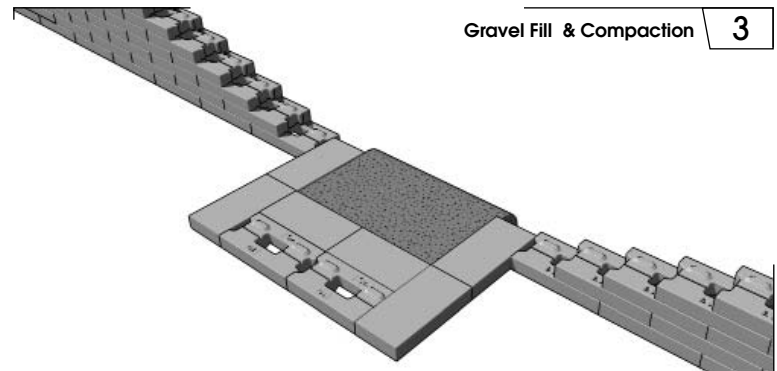

Fill the reinforced zone with imported, free draining gravel and compact to 95% SPD.

It is recommended to use a washed ¼" angular chip gravel. This material requires less rigorous compaction and will help prevent outward movement of the blocks due to compaction pressures during construction. (ASTM#8)

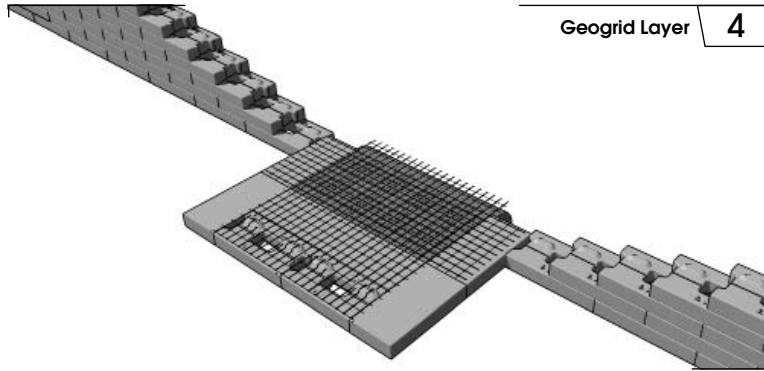

Geogrid Layer **4**

Experience has shown that the inclusion of geogrid reinforcement within each course of steps reduces the effect of settlement. It is recommended to include an additional geogrid layer every other step placed in the perpendicular principle direction.

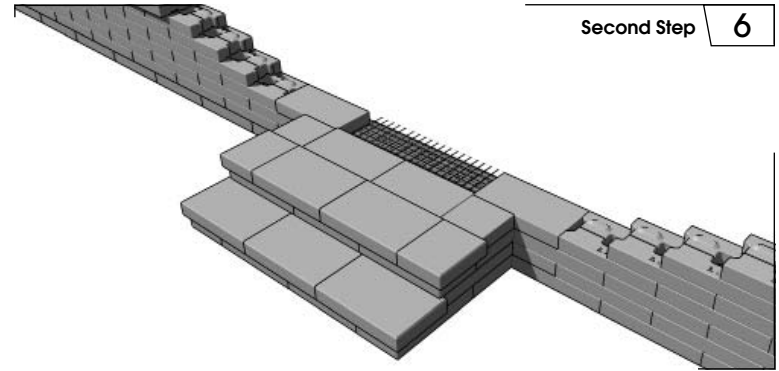

Second Step **6**

Utilizing the same technique as for the first step. Overlap the riser blocks 1" on top of the first step tread, this will improve the appearance of the bond pattern in the step side wall (refer to Cross-Section - Step 1)

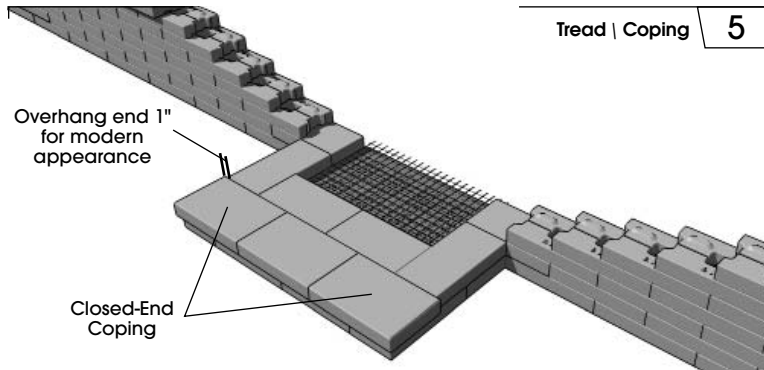

Tread | Coping **5**

Place coping blocks using the Step Groove (page 7) for proper nosing, utilizing closed-end coping on either end. Overhang the ends for a more modern appearance (optional). For best results, offset the cuts to create a bond pattern with the risers below. Place another row of corner or coping blocks directly behind tread/coping. Fill the reinforced zone with imported, free draining gravel and compact to 95% SPD.

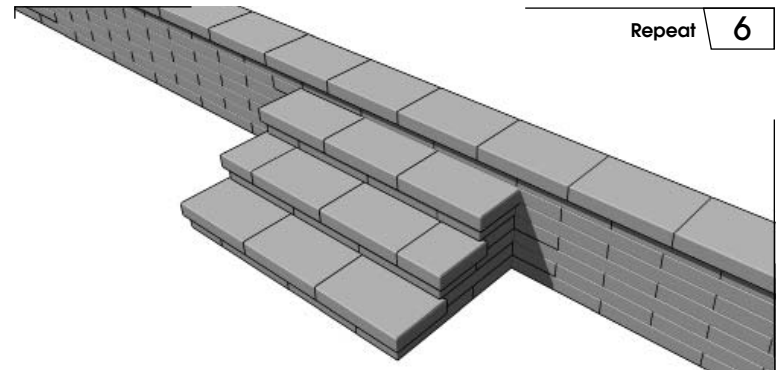

Repeat **6**

Repeat until desired wall height is achieved and finish off with coping blocks.

Gravity Wall Installation

The following are the basic steps involved in constructing a conventional (*non-geogrid reinforced*) PisaSmooth segmental retaining wall. These steps are to be used in conjunction with all relevant details. Refer to Overview of a Successful Project before beginning.

Note: Refer to Features & Advantages (*page 7*) for instructions on building small perfectly Vertical Walls. Vertical retaining walls should be limited to 2' (60cm).

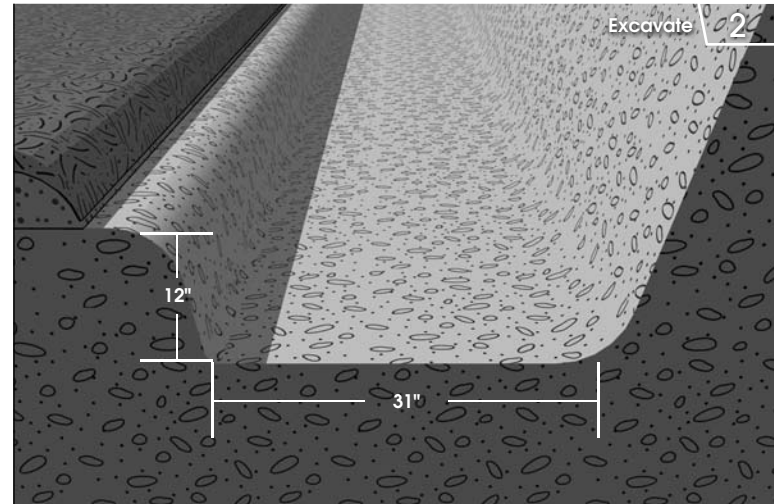
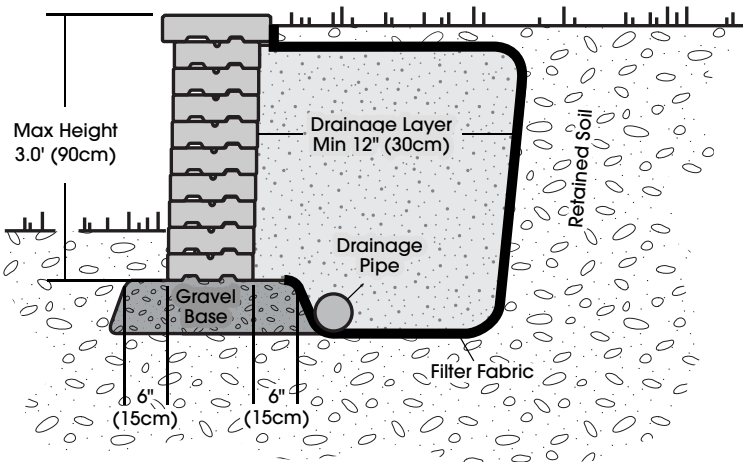

Planning Your Wall

With your Design in hand, begin to establish the wall location and proposed grades. Locate all utilities and contact local utility companies before digging. Mark a line where the front of the wall will be placed, keeping in mind the 1/8" (1cm) setback per course (*approx. 2° wall batter*).

Excavate the Base

Excavate a trench down to the foundation grades specified in the Design. The front of the trench should be 6" (15cm) from the planned face of the wall. The trench should be a minimum of 31" (79cm) wide (*front to back*) and a minimum 12" (30cm) deep. This depth assumes at least one block is buried (*NCMA requires a minimum 6" embedment*) plus the compacted granular base (*minimum depth of 6"*). As wall height increases, the depth of embedment also increases, normally about 10% of the wall height. Greater embedment depths may be required to account for slopes more than 3H:1V in front of the wall, scour protection in water applications, global stability, or as specified in the Design. The rear 6" of the trench is excavated to account for the drainage layer. Excavations should be conducted in accordance with local codes under direction of the General Review Engineer (GRE).

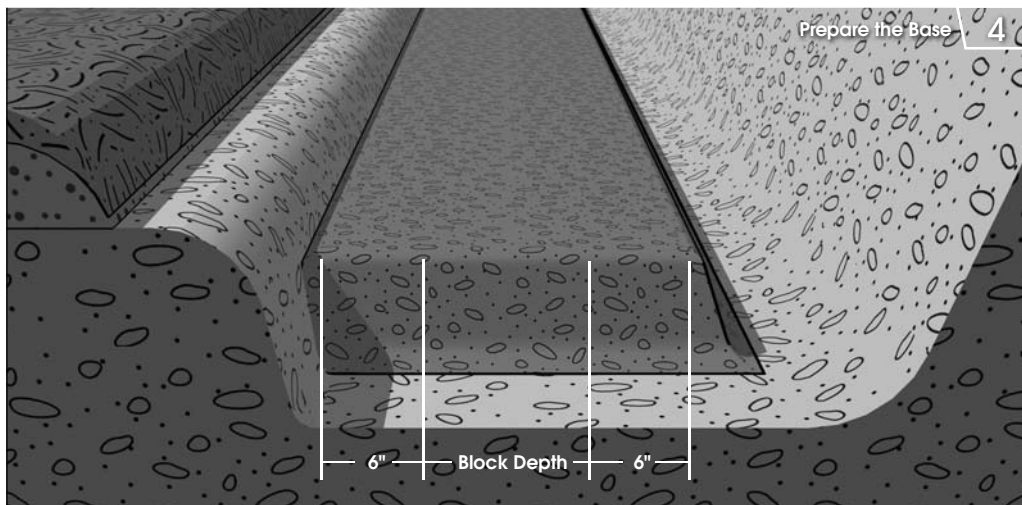

Verify Foundation Subgrade

Once the foundation trench has been excavated to the specified elevations, the native foundation soil must be checked by the GRE. The foundation soil must have the required allowable bearing capacity specified in the Design.

Prepare the Compacted Granular Base

Start the base at the lowest elevation of the wall. The base should be composed of well-graded, well-draining (less than 8% fines), angular granular material (commonly referred to as $\frac{3}{4}$ " minus or road base) and compacted to a minimum of 98% SPD. The minimum base thickness is 6" (15cm) or as required by the GRE to reach competent founding soil. At the direction of the GRE, geotextile might be required under the granular base. The minimum base dimensions are 23" (58cm) wide (*front to back*) and 6" deep. The additional 6" trench width allows for the placement of the drain.

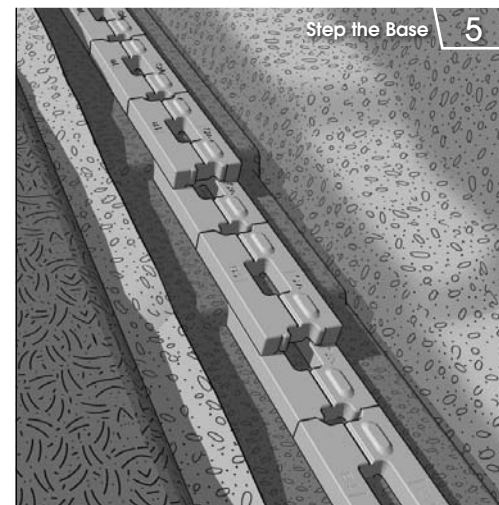

Step the Base

When the grade in front of the wall slopes up or down, the base must be stepped to compensate. The foundation steps must be located to ensure the minimum embedment is achieved. The height of each step is the block height of the course. The $\frac{1}{8}$ " (0.3cm) offset must be accounted for at each step (*approx. 2° wall batter*).

TIP: A layer of unreinforced concrete 2" (5cm) thick may be placed on top of the granular material to provide a durable leveling surface for the base course.

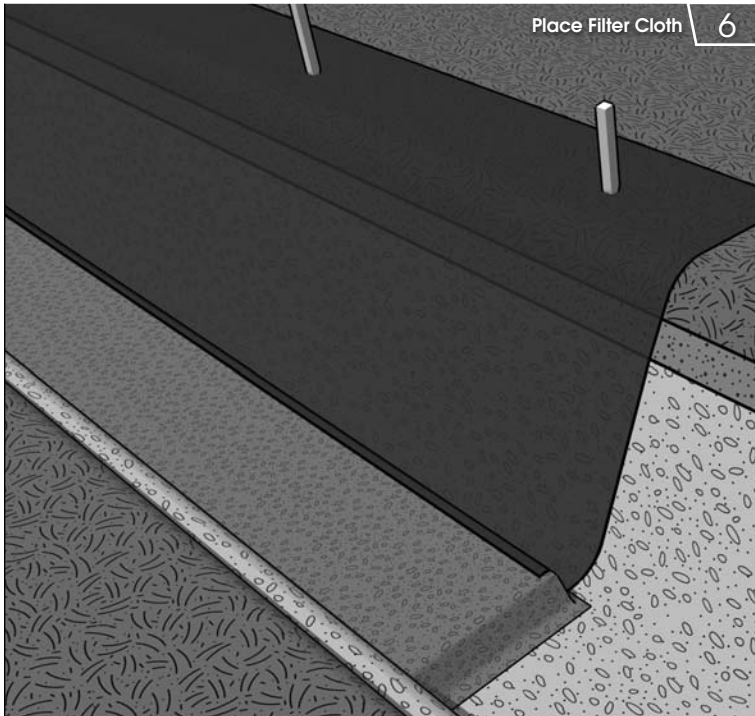

Place Filter Cloth (as required by Design)

Lay the approved filter fabric (*geotextile*) along the bottom of the rear of the trench and extend up the exposed excavation to the proposed wall height. Leave adequate material at the top to fold back towards the wall (*completely containing the drainage material*). Stake the filter cloth against the slope during construction. In some cases, if the Design permits, the Filter Fabric requirement can be avoided if the Drainage Material is graded to promote a natural soil filter system.

TIP: For more information on proper drainage requirements, refer to the Drainage information on page 30.

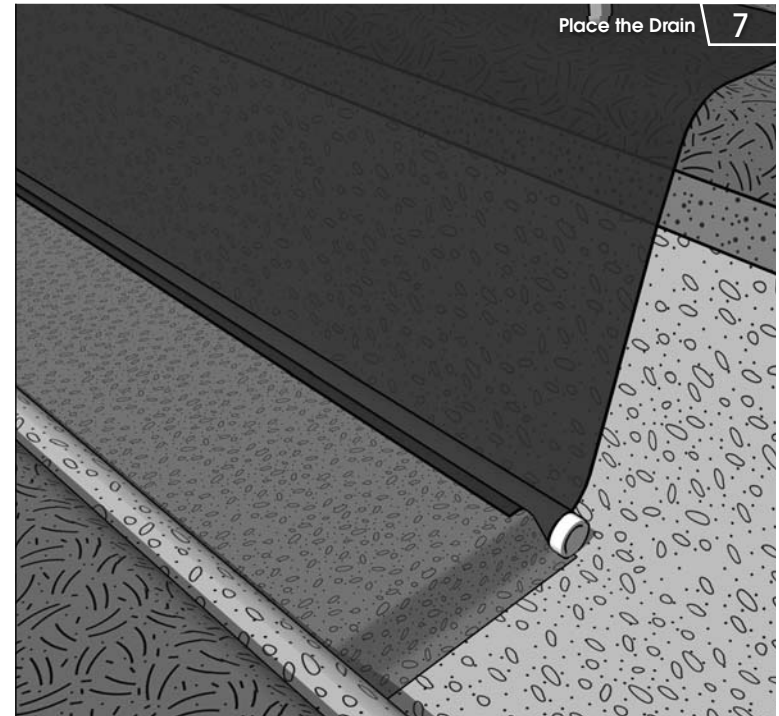

Place the Drain

Various options for drain placement may exist, depending on how the pipe is to be outlet (*refer to Drainage page 30*). The drain may be outlet through the wall face or connected to a positive outlet (*storm drain*).

The drainage system is extremely important and outlets must be planned prior to construction. In the case of connecting to a positive outlet, the drain should be placed at the lowest possible elevation and sloped at a minimum of 2%. At the rear of the base, allow the granular material to slope down on the sides towards the drain trench. In the 6" (15cm) area behind the base, place the approved drain tile (*perforated drain with filter sock*) on top of the filter cloth and minimal granular coverage.

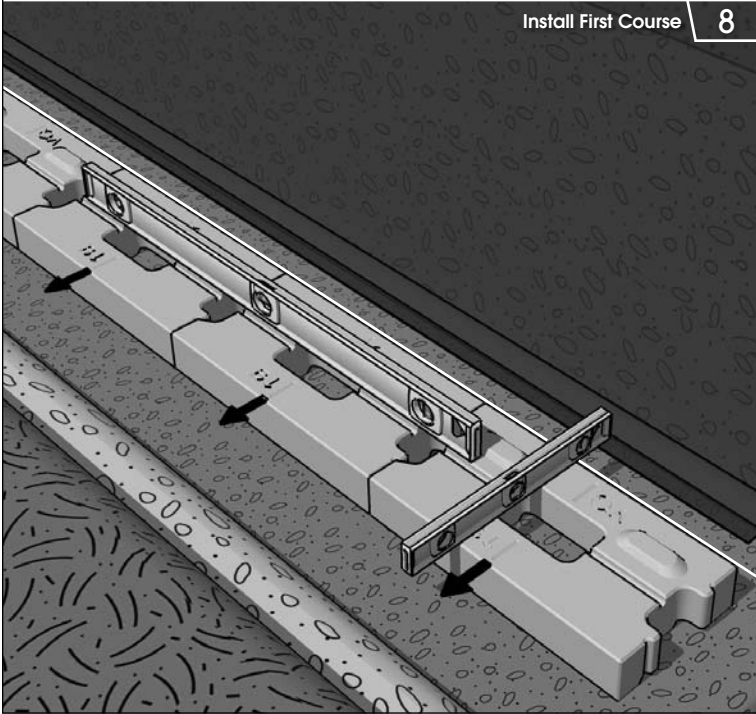

Place the First Course

Position a level string to mark the location of the back of the first course, which would be a distance equal to the block depth from the proposed Face of Wall. Place the first course of PisaSmooth blocks side-by-side (*touching*) on the granular base, with the Batter Indicator pointing **Forward**.

Ensure blocks are level front to back and left to right. Extra care should be taken at this stage as it is critical for accurate alignment.

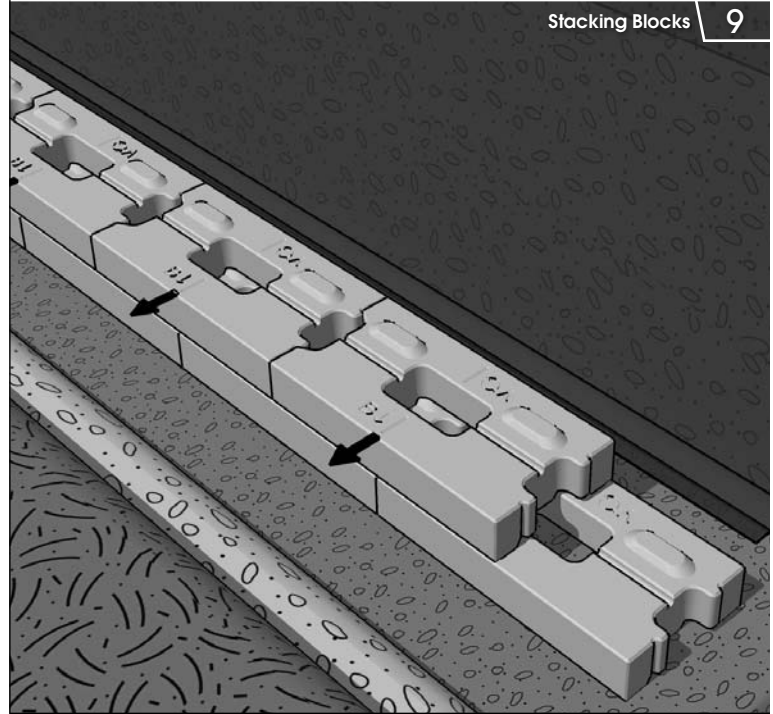

Stacking Blocks

Sweep the top of underlying course and stack next course in a running bond pattern, with the Batter Indicator pointing **Forward**. PisaSmooth uses a 1/2 bond pattern which can be achieved by offsetting adjacent course by the 10.75" (27.5cm) using the half block indicator.

NOTE: PisaSmooth can also create Vertical gravity walls with a maximum height of 2' (60cm), by rotating the blocks, alternating the Batter Indicator arrow Forward or Backward every other course (*page 7*).

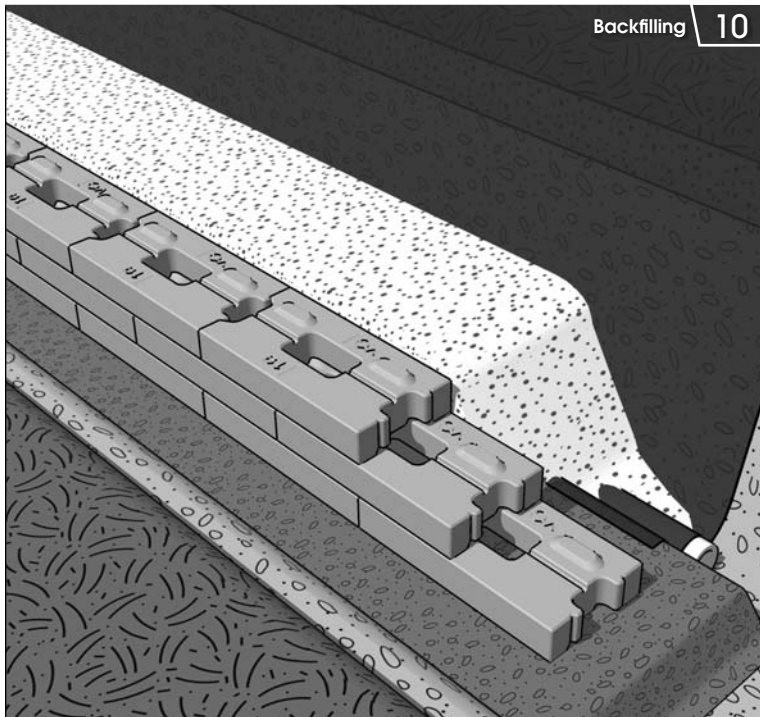

Backfill Drainage Material

A free-draining, gap-graded gravel ($\frac{1}{4}$ - $\frac{3}{4}$ " washed, angular) drainage material is placed immediately behind the wall facing and compacted with a light manual tamper. The drainage layer must be a minimum of 12" (30cm) thick and protected from the native material by the filter cloth or as required by the Design.

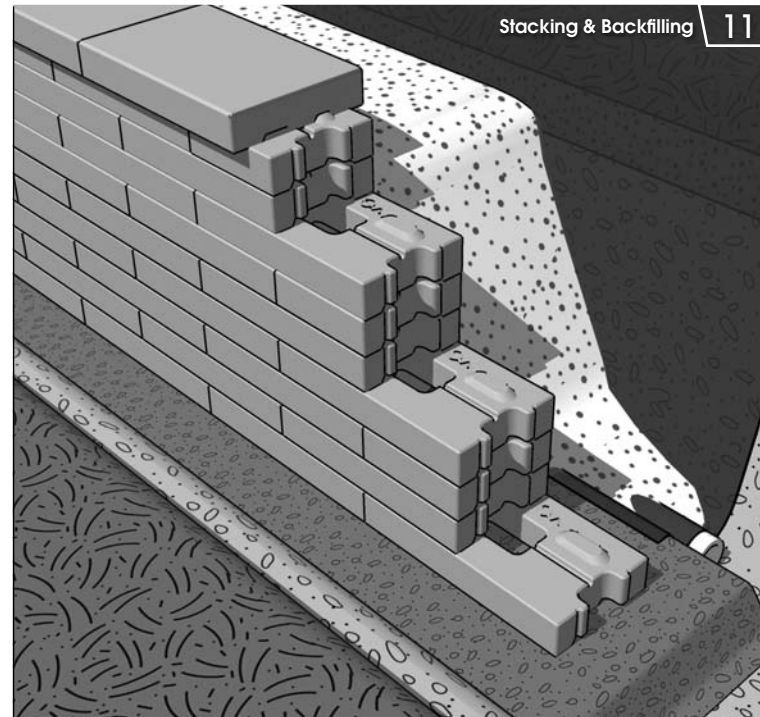

Continue Stacking and Backfilling

Continue stacking blocks and backfilling as described until the desired height is reached, based on the Design.

Place Coping Units

A layer of concrete adhesive must be applied to the top course in order to fix the coping units in place. Place the coping unit firmly on top of the adhesive, ensuring both surfaces are free of debris, and apply pressure to secure. Follow the adhesive manufacturer's installation guidelines.

Install coping using the Wall Groove for consistent overhang (page 7).

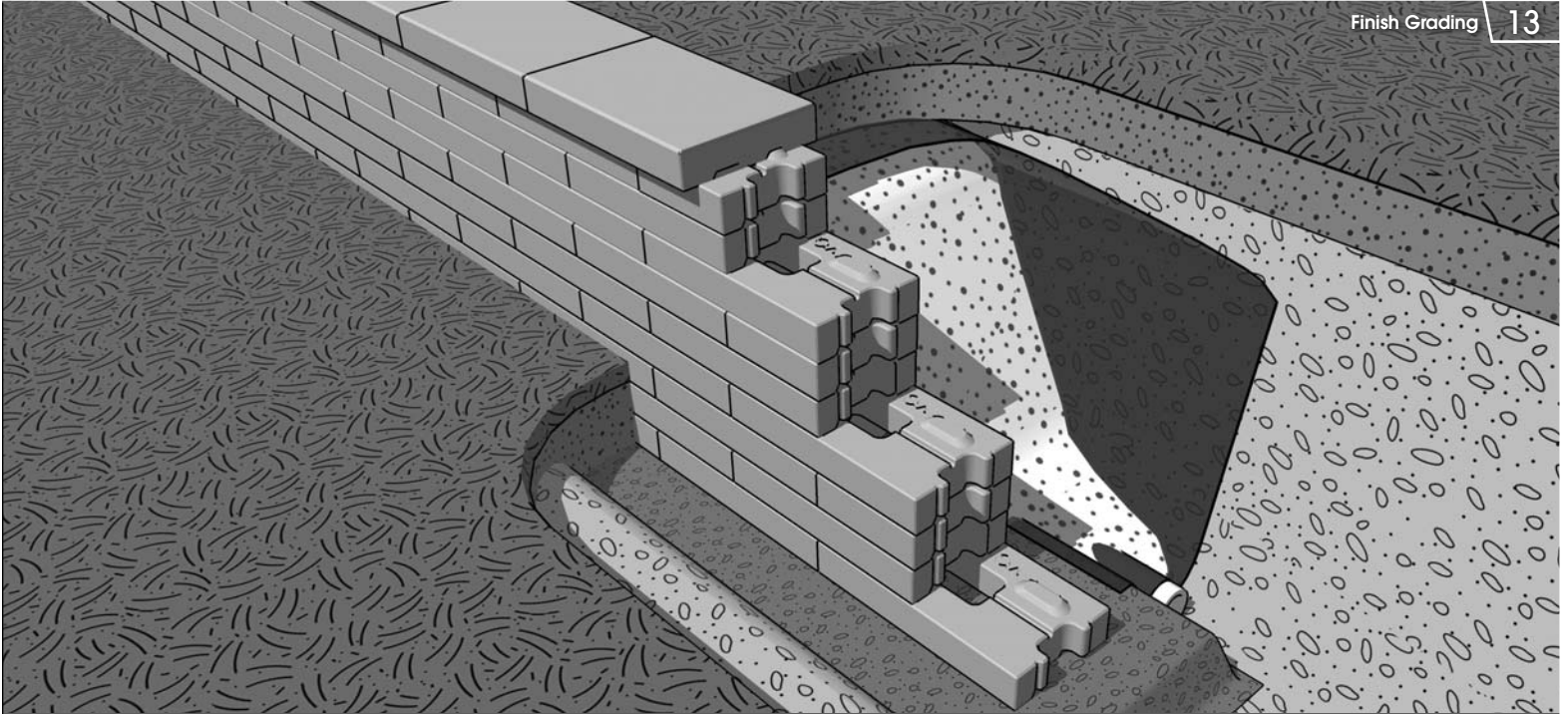

Encapsulate the Drainage Layer and Finish Grading

Fold the excess filter fabric (*if required*) over the top of the drainage layer and extend up the back face of the coping unit. Ideally, place an impervious layer of soil on top of the filter fabric and compact manually, providing for the required grading and/or swales. For other treatments such as pavers, concrete, or asphalt, care must be taken to ensure that heavy compaction/paving equipment remains a minimum of 39" (1m) from the back of the coping unit. Slope the surface above and below the wall to ensure that water will flow away from, and not accumulate near the wall units.

TIP: For more information on proper swale requirements, refer to the swale information on page 32.

Geogrid Reinforced Wall Installation

The following are the basic steps involved in constructing a Geogrid Reinforced PisaSmooth segmental retaining wall. These steps are to be used in conjunction with all relevant details. Refer to Overview of a Successful Project before beginning.

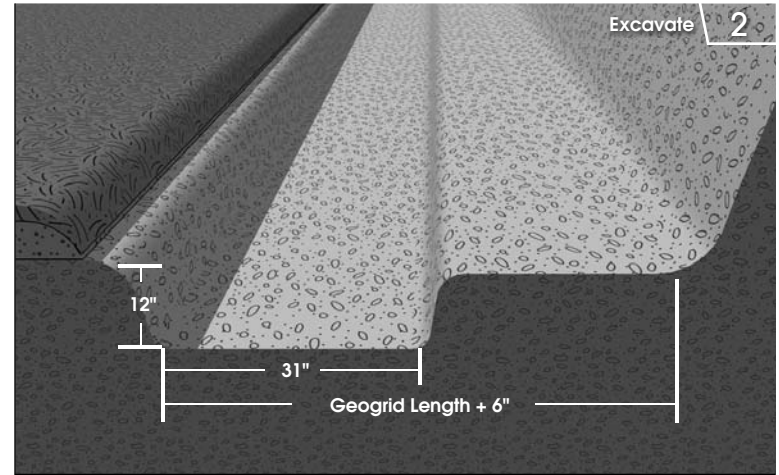
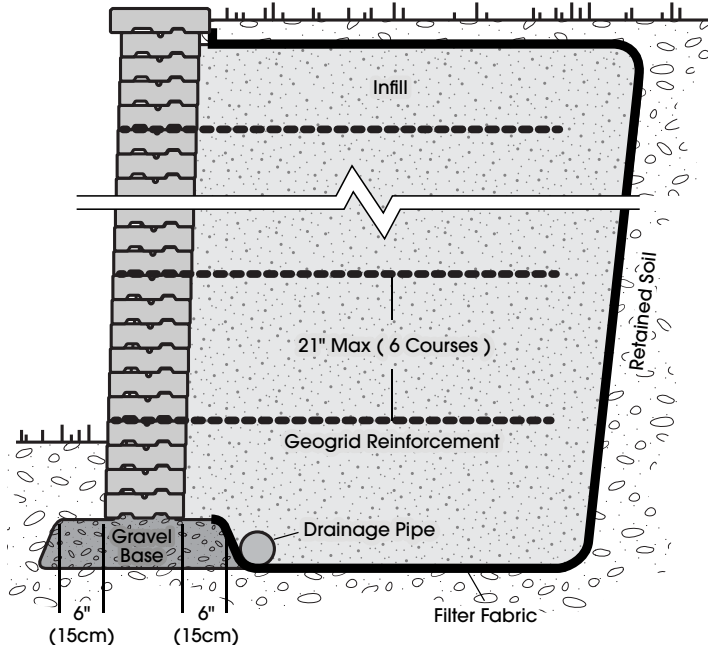

Plan

With your final Design in hand, begin to establish the wall location and proposed grades. Locate all utilities and contact local utility companies before digging. Mark a line where the front of the wall will be placed, keeping in mind the 1/8" (0.3cm) setback per course (approx. 2° wall batter).

Excavate Reinforced Zone

The excavation must be carefully planned; considering several elements. Based on the type of soil being excavated, the GRE must determine the maximum allowable "cut" angle the excavation can sustain. This angle ensures the stability of the excavation during construction. The required geogrid length (as shown in the Design) plus 6" (15cm) defines the minimum width at the base of the excavation. Measuring from 6" in front of the wall face, extend a line back the base width determined above. At the rear of the base dimension, an imaginary line should be extended up the slope at the allowable angle. Where this line breaks the slope surface is the beginning of the excavation. Excavation must then begin at the top of the slope and progress downwards at the acceptable angle. Excavation continues until the slope is cleared and a flat area at the base is exposed extending 6" past the proposed face of the wall.

Excavate Granular Base

Excavate a trench for the granular base. The front of the trench should be 6" (15cm) from the planned face of the wall. The trench should be a minimum of 31" (79cm) wide (*front to back*) and a minimum of 12" (30cm) deep. This depth assumes at least one block is buried (*NCMA requires a minimum 6" embedment or 10% of wall height*) plus the compacted granular base minimum depth of 6". As wall height increases, the depth of embedment also increases, normally about 10% of the wall height. Greater embedment depths may be required to account for slopes more than 3H:1V in front of the wall, scour protection in water applications, global stability, or as specified in the Design. The rear 6" of the trench is excavated to account for the drain.

Verify Foundation Subgrade

Once the wall has been excavated, the native foundation soil must be checked by the GRE. The foundation soil in a geogrid reinforced SRW is considered to be the native (*or fill*) material underneath both the facing and reinforced zone. The foundation soil must have the required allowable bearing capacity specified in the Design as verified by the GRE.

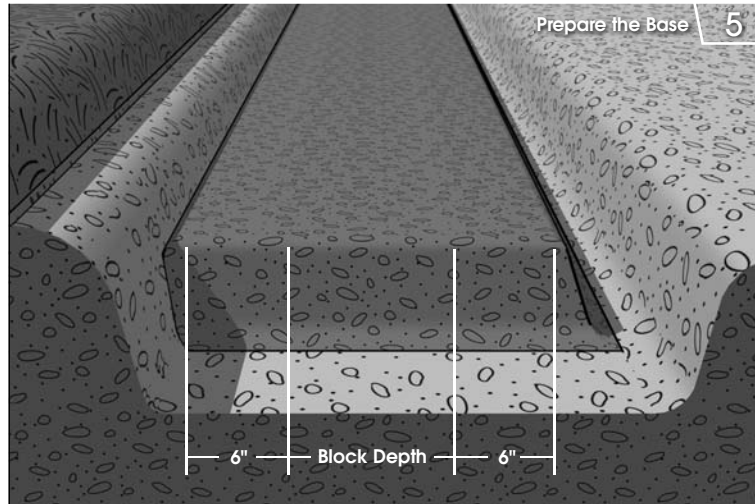

Prepare the Compacted Granular Base

The base should be started at the lowest elevation of the wall. The base should be composed of well-graded, well-draining (*less than 8% fines*), angular granular material (*commonly referred to as ¾" minus or road base*) and be compacted to a minimum of 98% SPD. The minimum base thickness is 6" (15cm) or as required by the GRE. The minimum base dimensions are 23" (58cm) wide (*front to back*) and 6" deep. The additional 6" trench width allows for the placement of the drain.

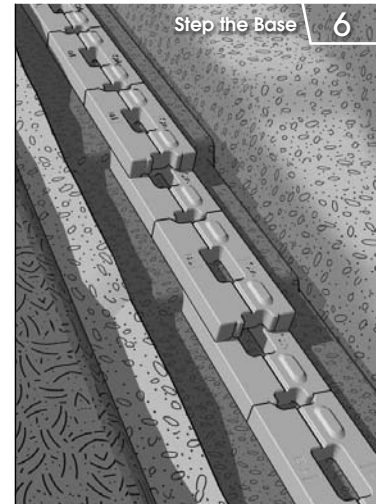

Step the Base

When the grade in front of the wall slopes up or down, the base must be stepped to compensate. The foundation steps must be located to ensure the minimum embedment is achieved. The height of each step is the block height of the course. The 1/8" (0.3cm) offset must be accounted for at each step (*approx. 2° wall batter*).

TIP: A layer of unreinforced concrete 2" (5cm) thick may be placed on top of the granular material to provide a durable leveling surface for the base course.

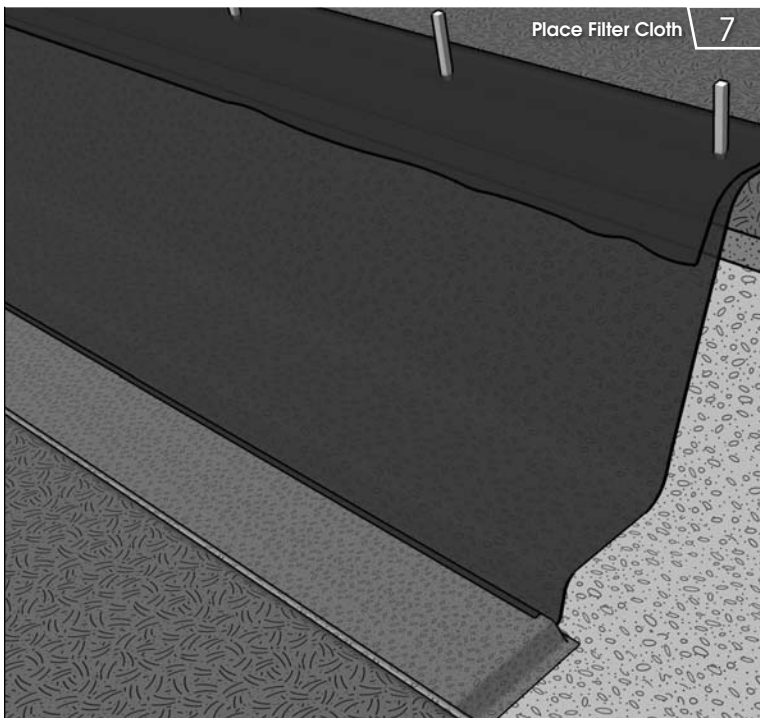

Place Filter Cloth (as required by Design)

Lay the approved filter fabric (*geotextile*) along the bottom of the rear of the trench and extend up the exposed excavation to the proposed wall height. Leave adequate material at the top to fold back towards the wall (*completely containing the drainage material*). Stake the filter cloth against the slope during construction. In some cases, if the Design permits, the Filter Fabric requirement can be avoided if the Drainage Material is graded to promote a natural soil filter system.

TIP: For more information on proper drainage requirements, refer to the Drainage information on page 30.

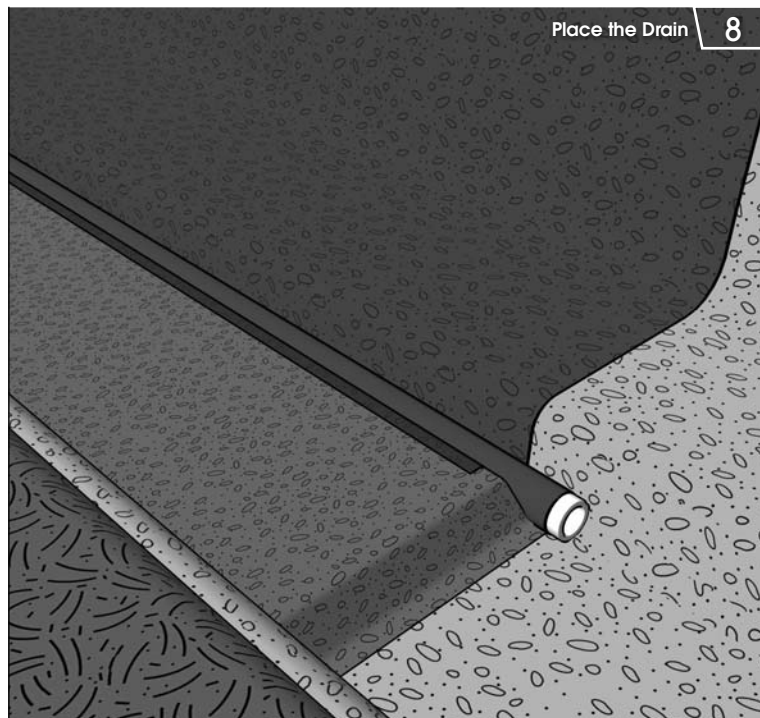

Place the Drain

Various options for drain placement may exist, depending on how the pipe is to be outlet (*refer to Drainage page 30*). The drain may be outlet through the wall face or connected to a positive outlet (*storm drain*).

The drainage system is extremely important and outlets must be planned prior to construction. In the case of connecting to a positive outlet, the drain should be placed at the lowest possible elevation and sloped at a minimum of 2%. At the rear of the base, allow the granular material to slope down on the sides towards the drain trench. In the 6" (15cm) area behind the base, place the approved drain tile (*perforated drain with filter sock*) on top of the filter cloth and minimal granular coverage.

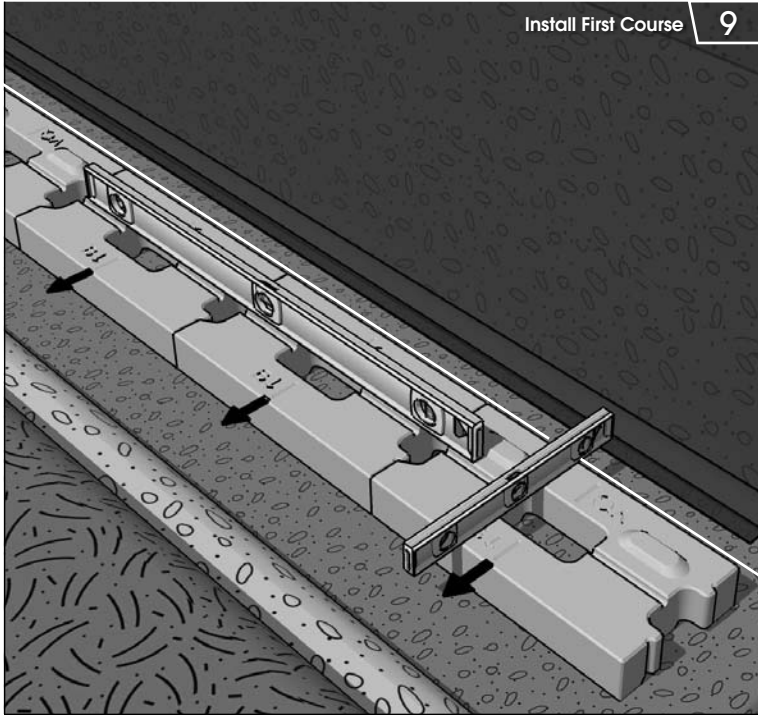

Ensure Blocks Are Perfectly Level

Position a level string to mark the location of the back of the first course, which would be a distance equal to the block depth from the proposed Face of Wall. Place the first course of PisaSmooth blocks side-by-side (*touching*) on the granular base, with the Batter Indicator pointing **Forward**.

Ensure blocks are level front to back and left to right. Extra care should be taken at this stage as it is critical for accurate alignment.

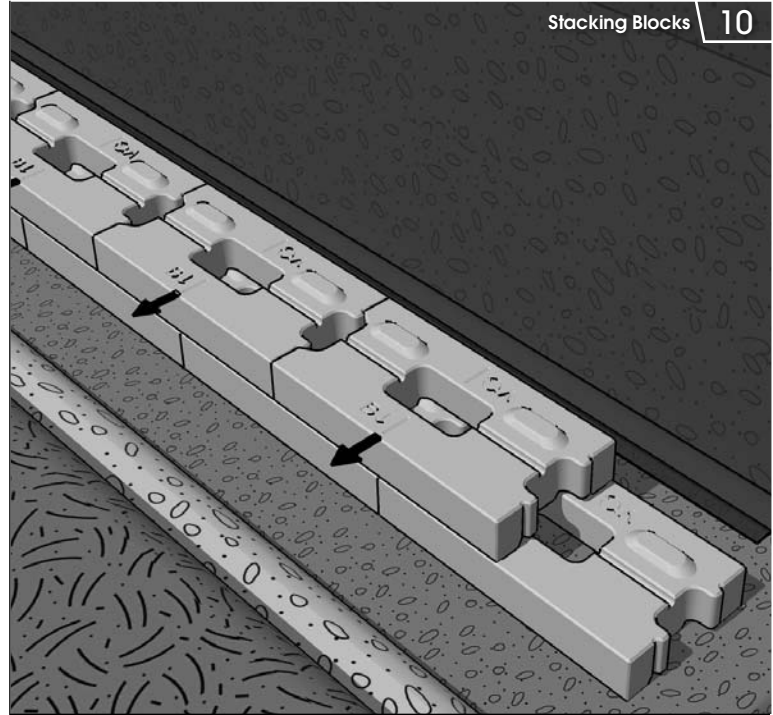

Stacking Blocks

Sweep the top of underlying course and stack next course in a running bond pattern, with the Batter Indicator pointing **Forward**. PisaSmooth uses a 1/2 bond pattern which can be achieved by offsetting adjacent course by the 10.75\"(27.5cm) using the half block indicator.

NOTE: PisaSmooth can also create Vertical geogrid reinforced walls by rotating the blocks, alternating the Batter Indicator arrow Forward or Backward every other course (page 7). Vertical walls maybe more susceptible to overturning, require additional geogrid layers and must be designed by a qualified engineer.

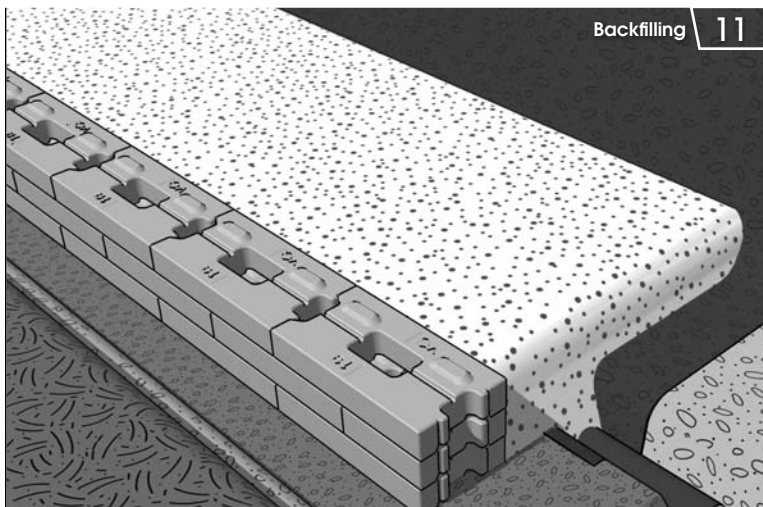

Backfill Infill Material

Begin backfilling the wall. Risi Stone recommends using an imported, well-graded, well-draining (*less than 8% fines*), angular granular material. In cases where the on-site material meets the minimum standards set out by the NCMA (*Refer to NCMA Design Manual, 3rd Edition*), it is possible to use native soils as backfill. However, additional considerations are required for drainage, reinforcement requirements, etc. The native soils must be properly assessed by the Site Geotechnical Engineer and the applicable Design parameters provided to the Wall Design Engineer.

The infill material is placed in maximum 6-8" (15-20cm) lift thicknesses and compacted to a minimum of 95% SPD. The compaction must be checked by the GRE at regular intervals. Continue backfilling up to the elevation of the first layer of geogrid reinforcement. Caution must be taken to ensure the allowable lift thickness is not exceeded and/or heavy compaction equipment is not operated within 36" (1m) of the back of the wall (*only hand-operated plate compactor*). Over compaction behind the wall facing will result in an outward rotation of the blocks and poor vertical alignment. Refer to Internal Drainage (*Page 30*) for other infill options.

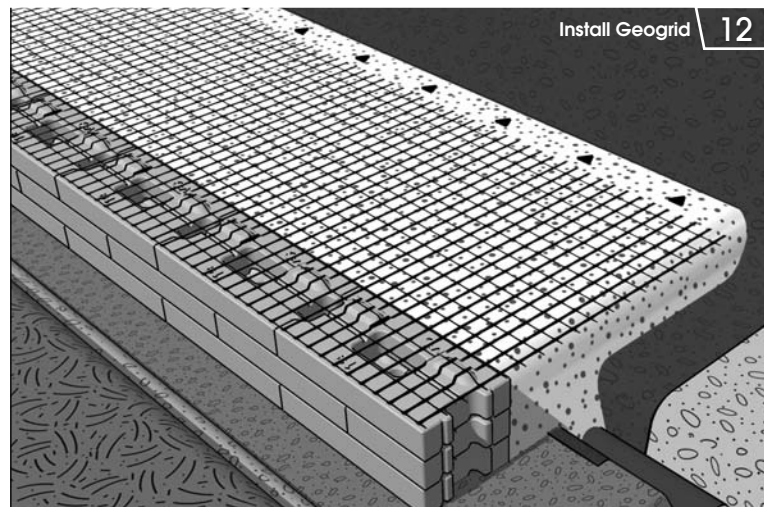

Install Geogrid Reinforcement

Ensure the geogrid reinforcement specified in the Design matches the product on site (*no substitutes are acceptable without consent of Design engineer*). Cut the geogrid from the roll to the specified length, ensuring the geogrid is being cut perpendicular to the direction of primary strength. Ensuring the PisaSmooth blocks are free of debris, lay the geogrid on top of the blocks to within 1" (2cm) of the face. Place the next course of PisaSmooth blocks (*as described above*) to secure the geogrid in place. Pull the geogrid reinforcement taut across the infill material to its full length and stake in place to maintain tension. The backfill material should be level with the back of the PisaSmooth block, allowing the geogrid to be laid out horizontally.

Geogrid Reinforcement must be placed with the "Strong Direction" (Machine Direction) perpendicular to the face, and within 1" (25mm) of the Block face.

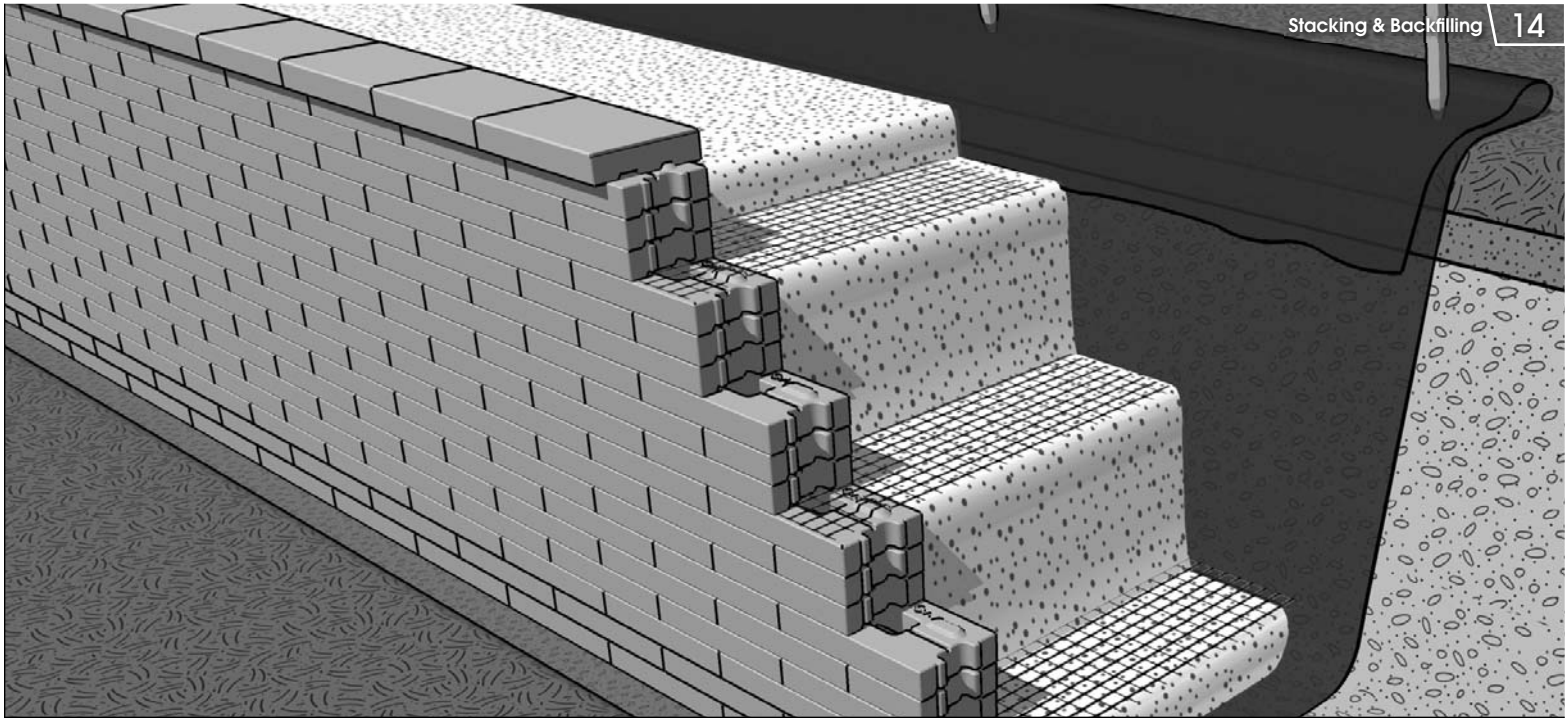

Backfill Over Geogrid Reinforcement

Backfill the next lift of granular infill material on top of the geogrid reinforcement, placing the loose material at the front of the wall, and raking it back away from the face (*this method maintains tension in the geogrid during backfilling*). Continue stacking and backfilling until the next layer of geogrid reinforcement is reached.

Continue Stacking & Backfilling

Continue placing the PisaSmooth blocks, backfilling, and laying the geogrid reinforcement as described above until the desired wall height is reached.

Place Coping Units

A layer of concrete adhesive must be applied to the top course in order to fix the coping units in place. Place the coping unit firmly on top of the adhesive, ensuring both surfaces are free of debris, and apply pressure to secure. Follow the adhesive manufacturer's installation guidelines.

Install coping using the Wall Groove for consistent overhang (page 7).

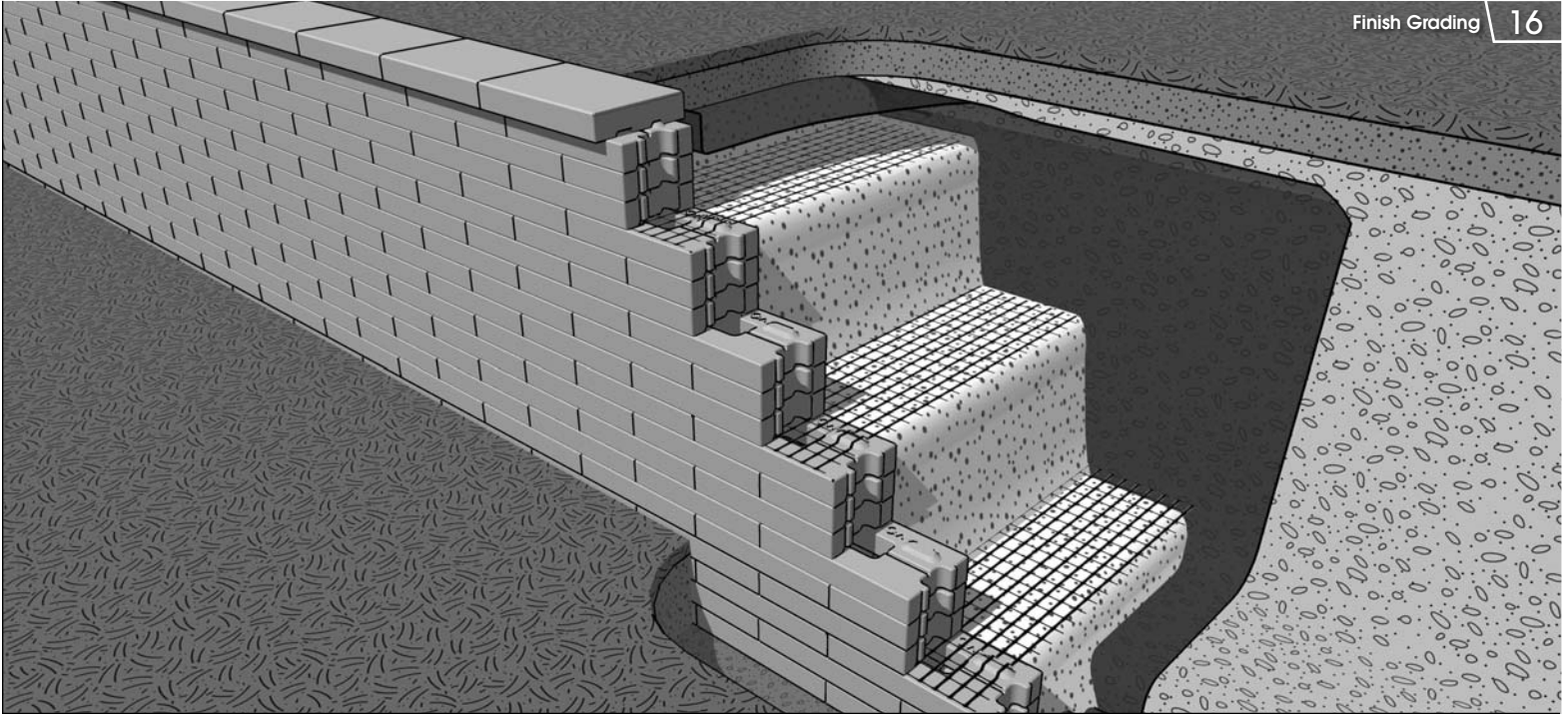

Encapsulate the Granular Infill & Finish Grading

Fold the excess filter fabric over the top of the infill zone (*reinforced zone*) and extend up the back face of the coping unit. Ideally, place an impervious layer of soil on top of the filter fabric and compact manually, providing for the required grading and/or swales. For other treatments such as pavers, concrete, or asphalt, care must be taken to ensure that heavy compaction/paving equipment remains a minimum of 39" (1m) from the back of the coping unit. Slope the surface above and below the wall to ensure that water will flow away from, and not accumulate near the wall units.

TIP: For more information on proper swale requirements, refer to the swale information on page 32.

Soil Conditions Imported Gravel & Clay

NOT FOR CONSTRUCTION

Soil Condition	Description	Φ -degrees	Block Weight (g-Lb/cu.ft)
Infill (Reinforced)	GW Well graded gravel, gravel sand, max 5% fine content	35	140
Retained	CL Inorganic Clays, low-medium plasticity	28	125
Foundation	CL Inorganic Clays, low-medium plasticity	28	125

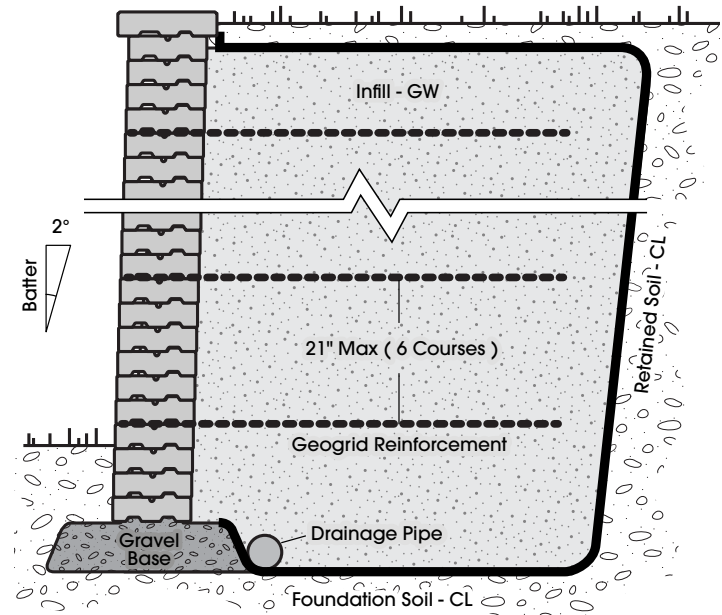

Exposed Wall Height (ft/m)	Embedment (ft/m)	Total Wall Height (ft/m)	No. Geogrid Layers	Flat Pedestrian Load (50psf / 2.4kPa)	Slope 3H:1V	Heavy Traffic (250psf / 12kPa)
				Grid Length (ft/m)	Grid Length (ft/m)	Grid Length (ft/m)
2.9 / 0.87	0.5 / 0.15	3.3 / 1.02	2	4.0 / 1.22	4.0 / 1.22	4.0 / 1.22
4.0 / 1.21	0.5 / 0.15	4.5 / 1.36	3	4.0 / 1.22	4.0 / 1.22	4.0 / 1.22
4.8 / 1.46	0.5 / 0.16	5.3 / 1.62	3	4.0 / 1.22	5.0 / 1.52	4.0 / 1.22
5.6 / 1.72	0.8 / 0.23	6.5 / 1.95	4	5.0 / 1.52	5.5 / 1.68	5.0 / 1.52
6.8 / 2.06	0.8 / 0.23	7.5 / 2.29	5	5.5 / 1.68	6.0 / 1.83	5.5 / 1.68
7.6 / 2.31	0.8 / 0.23	8.4 / 2.55	5	6.0 / 1.83	7.0 / 2.13	6.5 / 1.98
8.4 / 2.57	1.0 / 0.32	9.5 / 2.89	6	6.5 / 1.98	7.5 / 2.29	6.5 / 1.98

Disclaimer: Geogrid Reinforcement to be Stratagrid 200 or engineer approved equivalent. The above design information is being provided for preliminary estimate and feasibility purposes only and should not be used for construction. Prior to wall construction, a Final Design must be supplied by a qualified Engineer licensed in the applicable State/Province. Handrails and/or traffic barriers are not shown but are typically required and may influence the wall design. The above Design is not to be used with terraced walls, water applications or within the line of influence of other permanent structures.

Internal Drainage

Proper drainage of a segmental retaining wall is one of the most critical aspects of design and construction. Unless otherwise stated, the Design assumes that no hydrostatic pressures exist behind the wall. To ensure this condition is met, water flow from all directions and sources must be accounted for in the Design through proper grading and drainage measures, diverting water away from the wall whenever possible.

Outlet to Drain | Catch Basin

If the drain is being connected to a catch basin or other positive outlet, it should be located at the lowest elevation possible. Placing the drain at the founding elevation ensures better drainage of the base and subsoils. A minimum 2% slope is recommended.

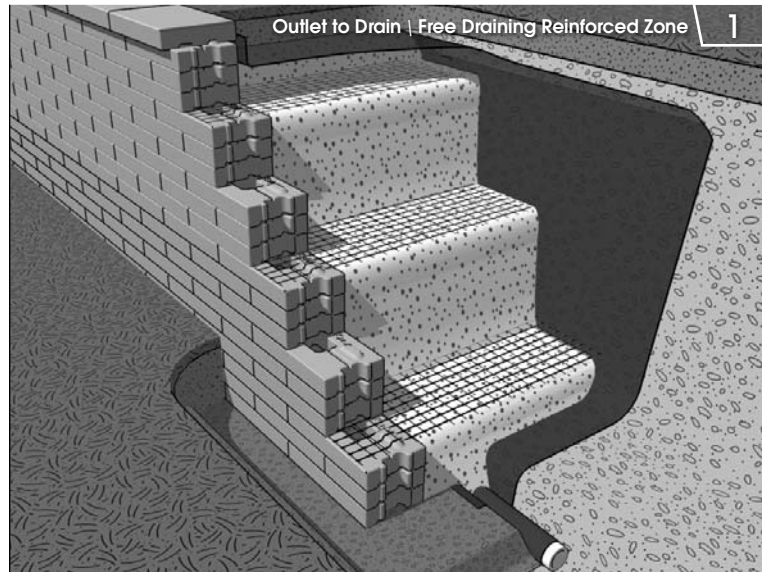

Outlet Through Face

If the drain is being outlet through the face of the wall, it is recommended that an approved, less pervious engineered fill material be compacted under the drain up to the grade in front of the wall. This measure collects water percolating through the reinforced zone and directs it to the drain, rather than allowing the base to become saturated. The outlet pipe should be a non-perforated PVC (connected through a T-joint) placed a minimum of 45ft(13.5m) on center (or as required by the Design). Cutting a block to fit allows the pipe to protrude through the wall face without losing the running bond pattern. Seal around the pipe outlet to ensure backfill does not escape.

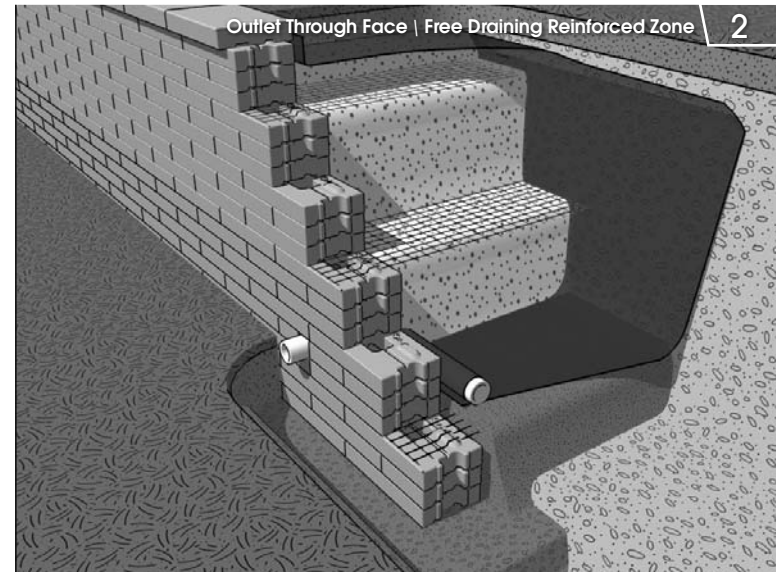

Well-Draining Reinforced Zone

As the construction of a separate drainage layer immediately behind the facing blocks can be cumbersome and reduce efficiency, a popular option is to use a well-draining, granular material for the reinforced zone. It is recommended that this material be well-graded, with less than 8% fines. An approved filter cloth may be required between the reinforced zone and retained/foundation soil to prevent the migration of fines, depending on the relative gradation of each material. The use of an imported granular material in the reinforced zone has many other advantages besides its good drainage properties. In most cases, if the reinforced zone is a well graded gravel, a natural soil filter is established and filter fabric is unnecessary.

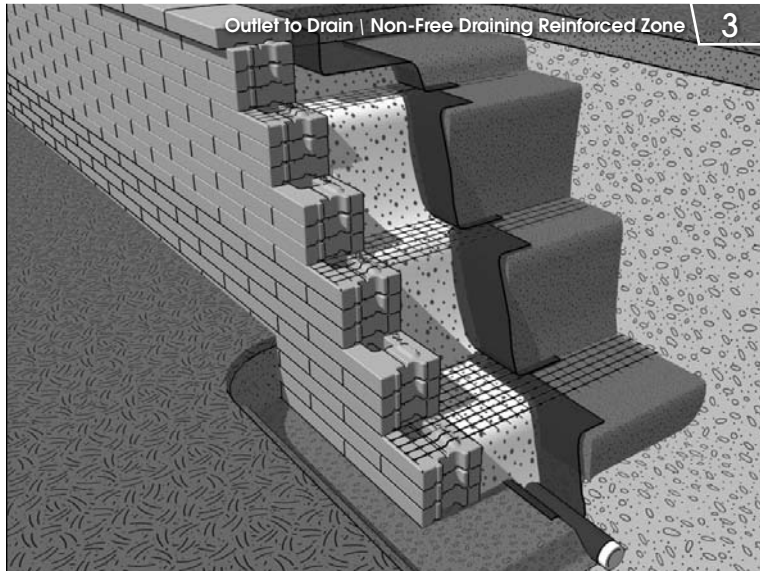

Non-Free-Draining Reinforced Zone

If the infill material being used to construct the reinforced zone is not considered to be well draining ($>8\%$ fines), a drainage layer is required immediately behind the face of the wall. The drainage material must be a minimum of 12" (30cm) thick, composed of a gap-graded, free-draining ($<5\%$ fines), angular clean stone. An approved filter cloth must be placed between the drainage layer and the infill material to prevent the migration of fines and contamination of the drainage material. At each geogrid layer, the filter cloth must be pulled back into the reinforced zone a minimum of 6" (15cm) and cut. The drainage layer must be fully encapsulated with a 6" overlap at each geogrid elevation as shown.

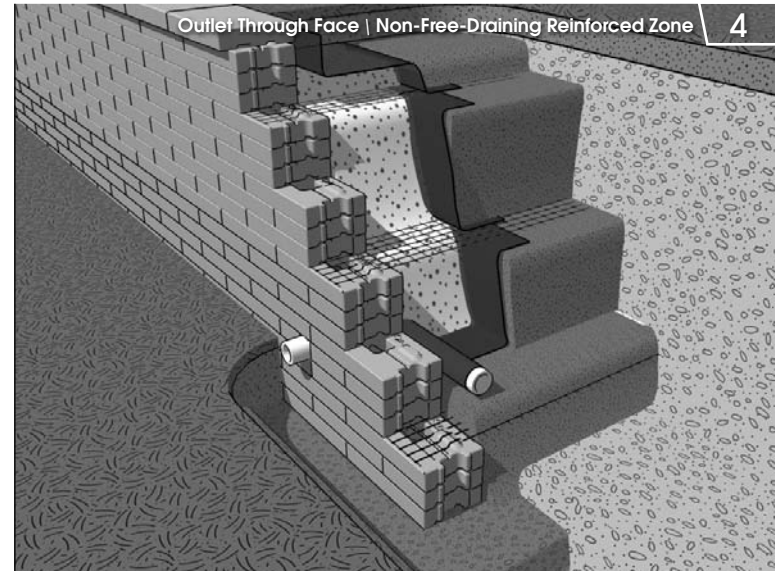

External Drainage

The use of swales above and below the walls to divert water away is an effective, low-cost method of ensuring good drainage. The swale must be composed of an impervious or low permeability material (*asphalt/ concrete or approved clay*). The swale must be Designed (*dimensioned*) by the Civil Engineer as part of the overall site drainage plan.

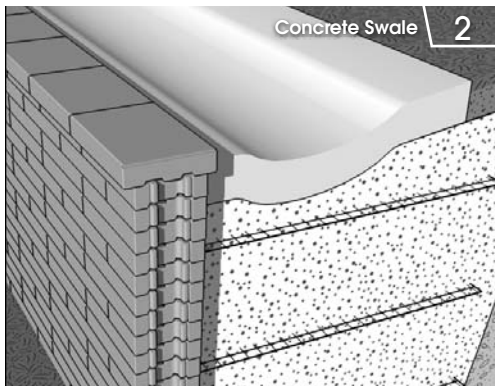
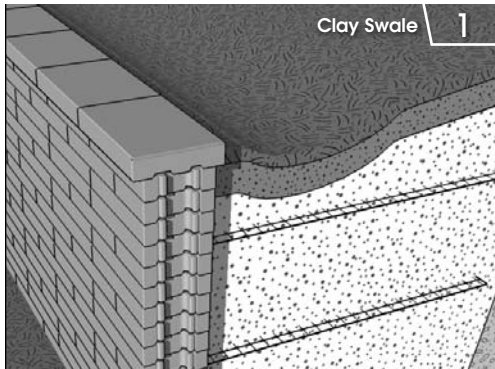

Posts & Obstructions

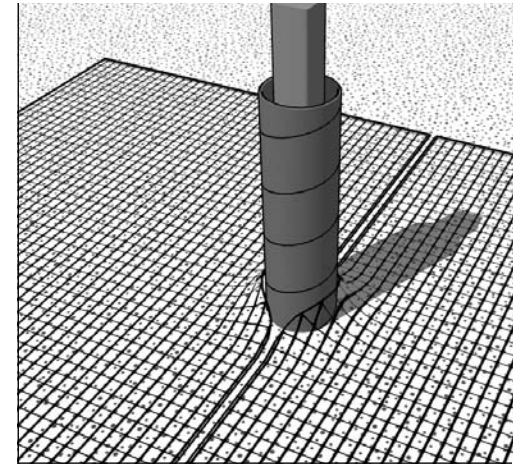
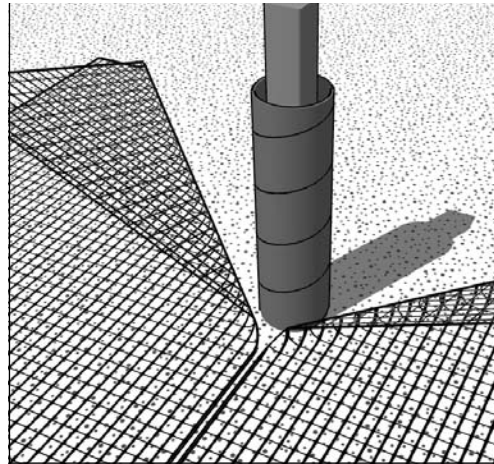

Guard Rails & Chain Link Fences

A pedestrian Guard Rail or Chain Link Fence is usually required for walls over 24" (60cm) in height where pedestrians have access (*check with your local building code*). These Guard Rails must act to resist potential lateral pedestrian loads.

Unless provided for in the Design, a Handrail must be founded in a concrete sonotube placed behind the Wall. For Gravity (*unreinforced Walls*), this sonotube must extend down below the base of the Wall into a socket of native material to ensure it does not rely on the Wall for stability.

For Geogrid reinforced Walls, the concrete sonotubes are placed within the reinforced zone while the wall is being constructed. If these are not installed during the Wall construction, the Geogrid can be damaged when the Contractor attempts to auger through the reinforced zone later.

To place the sonotubes, cut the geogrid perpendicular to the wall along the centerline of the sonotube, creating two geogrid panels – one on each side of the sonotube. Lay the geogrid flat in front of the sonotube. At the intersection with the sonotube, fold the geogrid flat against vertical side of the sonotube and then around the back, maintaining the edge of the geogrid along the centerline of the sonotube. Lay the geogrid flat behind the sonotube and pull taut.

Secure the geogrid in place at the face (*with the next course*) and at the rear (*with stakes*) and continue backfilling.

Repeat the previous steps for each layer of geogrid encountered by the sonotube.

Geogrid Reinforcement must be placed with the "Strong Direction" (Machine Direction) perpendicular to the face, and within 1" (25mm) of the Block face.

Wood & Privacy Fences

For Wood or other Privacy fences, additional Wind Loads must be taken into account by the Wall Designer. Based on these forces, a minimum foundation depth and geogrid layout will be recommended for the top of the Wall. Typically, a 6ft(1.8m) sonotube depth, or greater, is used for wind bearing elements.

As with Guard Rails described above, the sonotubes are placed during the Wall construction to avoid damaging the Geogrid later. As shown above, Geogrid is wrapped around the sonotubes at each layer. All reinforced material must be well compacted around the sonotubes.

Traffic Guide Rails

For areas adjacent to roadways and parking lots, flexible steel beam or wood guide rails may be placed behind a geogrid reinforced wall in accordance with the applicable governing standards. Additional "crash" loads must be accounted for in the Design of the wall. Accepted procedures usually require the guard rail posts to be offset a minimum of 36"(1m) from the face of the wall, extending a minimum of 5ft(1.5m) into the reinforced zone. It is recommended that the posts be placed as the wall is constructed and compaction surrounding the posts be carefully monitored to ensure optimum confinement.

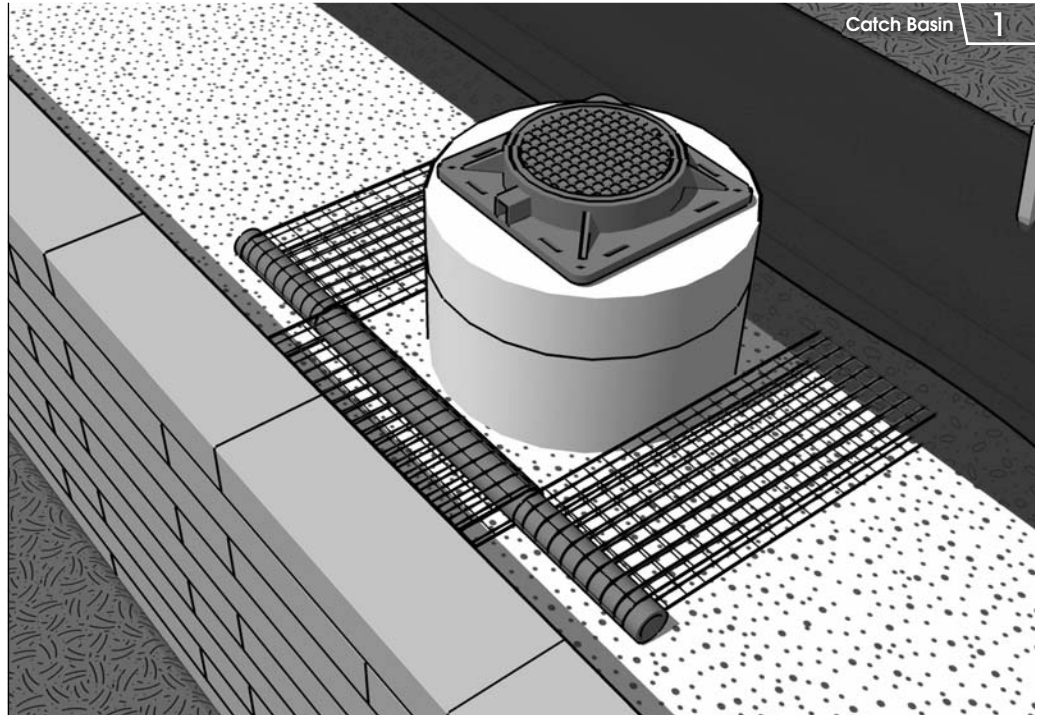

Catch Basin

Although it is recommended by the NCMA to locate catch basins and other underground structures outside of the reinforced zone, some site plans may require it. When a catch basin is interfering with the placement of the geogrid reinforcement as specified by the site-specific Design, measures can be taken by the Wall Designer to span around the obstruction with a system of geogrid and steel pipes. An example is shown above. The final sizing of elements will be per the Design.

MANUFACTURED
UNDER LICENSE



RisiStone
retaining wall systems

For more information about the correct product for your next Retaining Wall project,
visit our website or contact Risi Stone Inc.

1.800.626.WALL | www.RISISTONE.com | Info@risistone.com

PisaSmooth™ Supplier \ Manufacturer \ Contractor